



edmonton.ca/Waste

.....

Waste Collection at Apartments and Condos

A Guide for Property Managers

Third Edition · August 2024

Edmonton



Table of Contents

1	What's changing?	· food scraps, recycling and garbage
2	Bylaw requirements	· list of requirements · co-location
4	Sorting helps manage waste volumes	· accessible waste containers · flattening boxes · extra collection
6	What is the City doing to help?	· property manager support · resident support
8	Your role	· informing current residents · informing new move-ins · contributing to safe and efficient waste collection
12	Preventing and solving problems	· waste not collected? · frozen food scraps · illegal dumping · missing carts
14	Download WasteWise	· online tool · mobile app

What's changing?

.....

A new waste collection system is coming to Edmonton apartments and condos.

By the end of 2027, all Edmontonians will be **sorting their waste** for collection into **food scraps, recycling** and **garbage**.

When food scraps and recyclable materials are collected separately, they can be turned into compost, energy or new products, and emissions from landfilling are reduced.

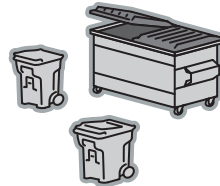
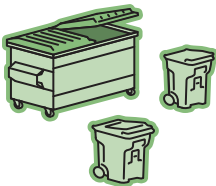

Food scraps will be collected in green carts or bins; recycling will be collected in blue bins; and garbage will be collected in brown or grey bins or grey carts.

Bylaw requirements

.....

The Waste Services Bylaw (20363) includes the following requirements:

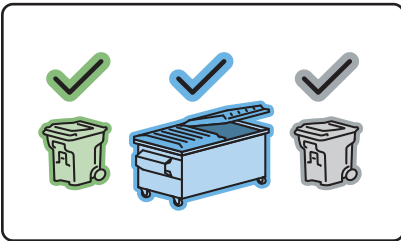

Three waste streams at all disposal locations

.....

Apartment and condo residents must sort their waste into food scraps, recycling and garbage.

There must be containers for each type of waste at all disposal locations.

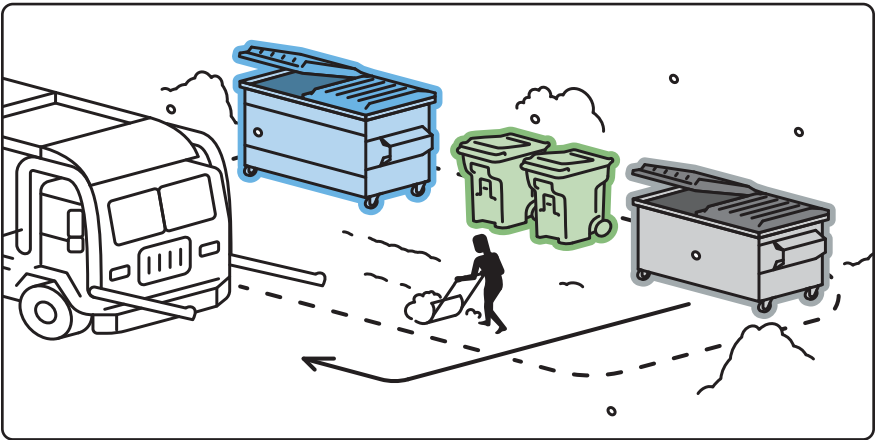

Accessible collection area

.....

All carts and bins must be safely accessible and have a clear path to the collection area (often a parking lot, alley or roadway). This means it is your responsibility to remove snow, ice, carts, vehicles and other objects before collection. **If the collection area isn't accessible, waste will not be collected.**

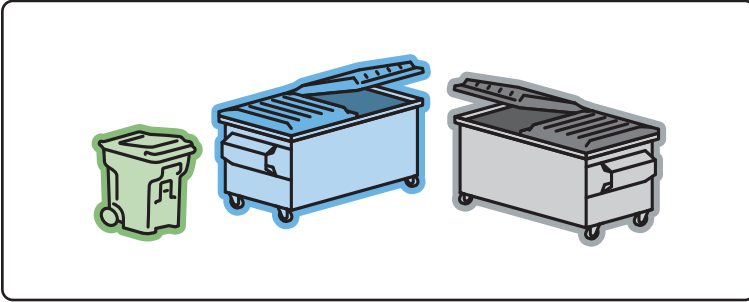

Co-located containers

.....

Food scraps, recycling and garbage containers must be “co-located”—side by side, equally convenient and accessible to residents—in all disposal locations.

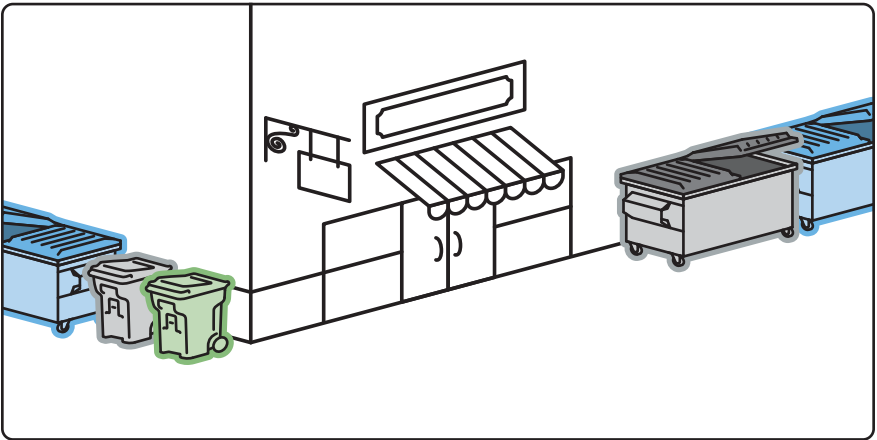

Separate containers for businesses

.....

If you have a business on your property, it must have its own waste containers, and be serviced by a private waste collector.

Sorting helps manage waste volumes

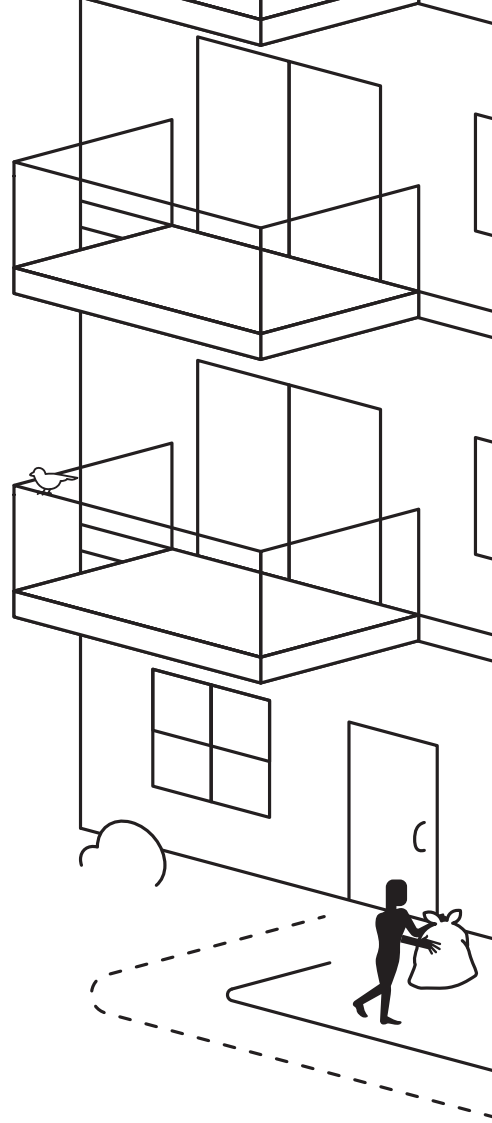

In the past, garbage, food scraps and recycling were all put in the same bin.

But now that food scraps and recycling will be removed, there will be less garbage. This means your garbage container will likely have enough space, even if it's smaller.

Flatten cardboard boxes to make space in recycling bins.

If residents are sorting their waste and you still find your bins are overfilled before collection day, you can request an extra collection for a fee.

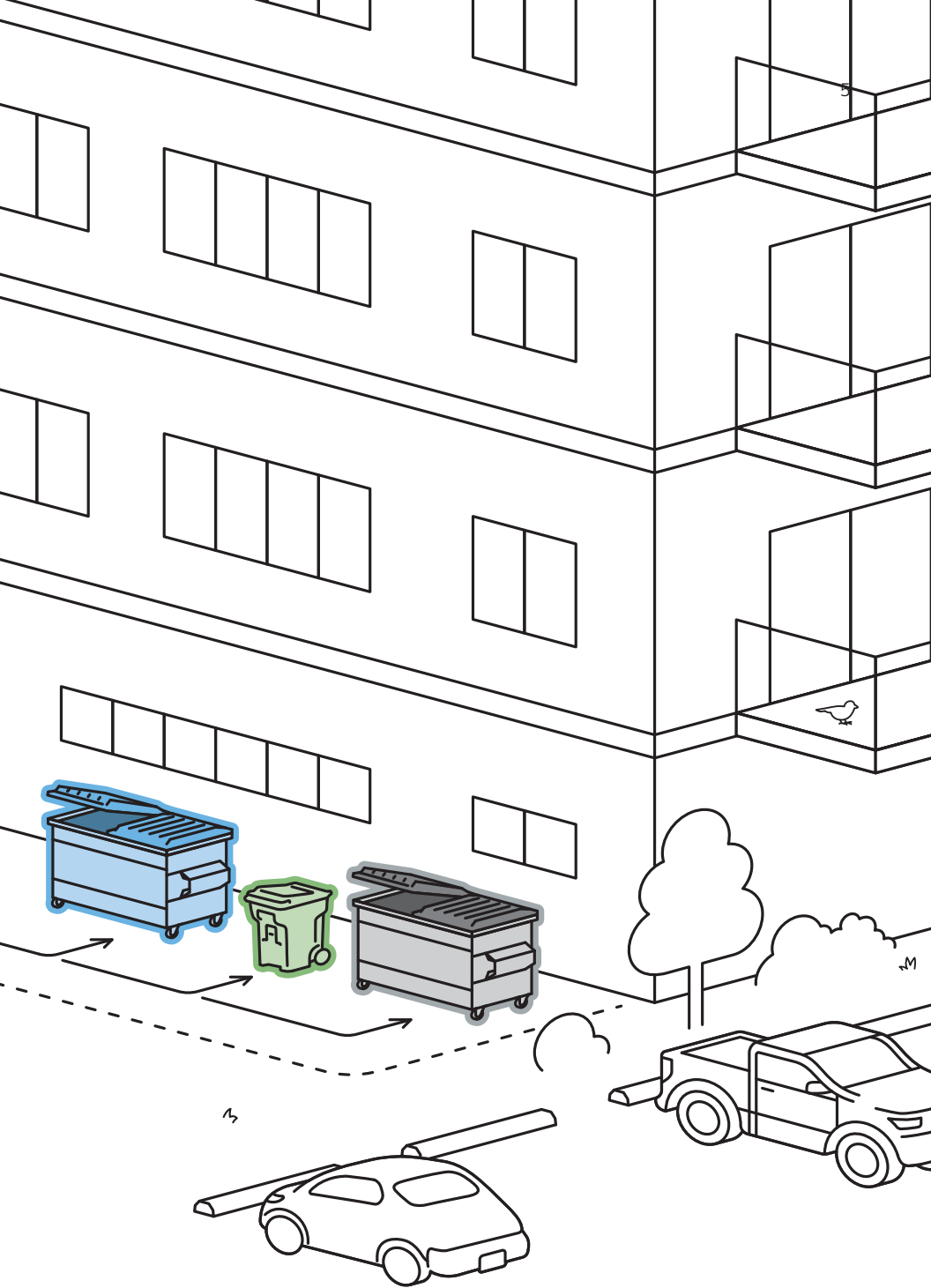

Visit edmonton.ca/ApartmentandCondoCollection to learn more.

What is the City doing to help?

.....

Property manager support

We're here to help you and your residents adapt to the new waste collection system.

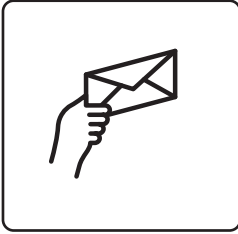

Watch for your assessment letter

.....

EPCOR account holders will receive an assessment letter with a recommendation for waste containers that will work for your property.

Please confirm the assessment or request a review. If you do not receive the letter, please contact your building owner.



Do you need help?

.....

Contact Waste Customer Support:
email **WasteSupport@edmonton.ca**
call **780-496-5698**



visit **edmonton.ca/Waste**
for information for residents
and property managers.

Resident support

Each residence will receive their own information and support tools.



Tools for residents

.....

When food scraps and recycling carts and bins are delivered to your building, each residence will receive:

- **A booklet with information to help them get started**
- **A What Goes Where poster**
- **A food scraps pail**



WasteWise app

.....

Residents can use the app or online tool to help them sort their waste. (see back cover of this booklet)



Waste education

.....

City waste education staff will visit each unit to answer questions about the program. Property managers will be contacted with more details closer to the program start.



311 support

.....

Residents can also contact **311** if they have questions.

Your role: Informing current residents

Part of your role is to help residents learn how to sort and where to dispose of food scraps, recycling and garbage. Here's how to use the tools the City has provided with this booklet:

- Print and distribute a copy of the Resident Handout to each unit, or post it in common areas before your containers are delivered.** Scan the QR code to find the handout and your rollout year.



- Display the What Goes Where poster at every indoor disposal location.**

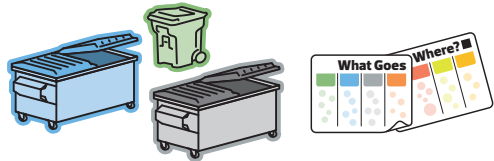

- If needed, print additional What Goes Where posters from the property manager webpage** (scan the QR code or visit edmonton.ca/Waste).

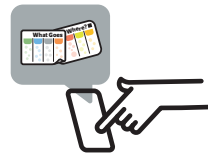

- Tell residents they are expected to sort their waste. Answer questions if you can, or refer them to edmonton.ca/Waste.**



Your role: Informing new move-ins

Once the program is established in your building, it will be your responsibility to introduce new residents to waste disposal:

- Tell them they are expected to sort their waste.

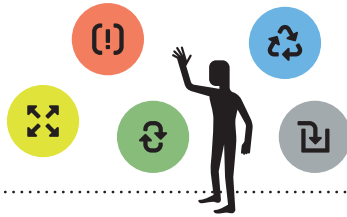

- Give them an information booklet and What Goes Where poster (request more by emailing WasteSupport@edmonton.ca).



- Show them where to put their food scraps, recycling and garbage.

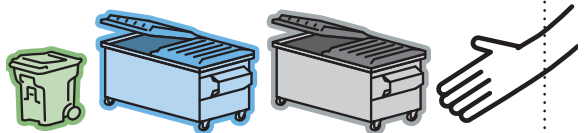

To find information and resources and sign up for email updates, scan the QR code, or visit edmonton.ca/Waste and click "Apartment and Condo Waste Collection Changes."

Questions? Email WasteSupport@edmonton.ca

Your role: Contributing to safe and efficient waste collection

Once your food scraps and recycling containers are delivered, please take the following steps to help us collect waste safely and efficiently.

Taking these steps will help ensure your waste is collected, and fees for extra collection are avoided.

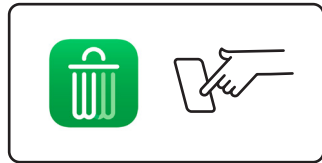
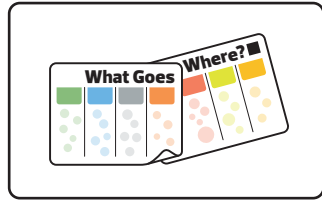
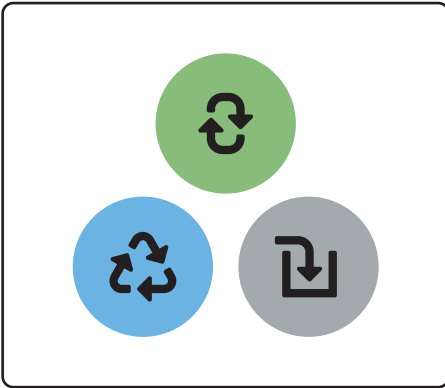

Learn what belongs in each container by using the What Goes Where poster or the WasteWise app.

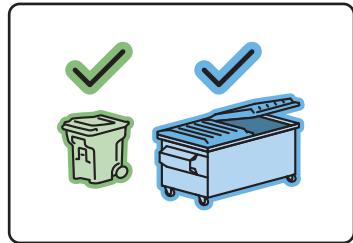
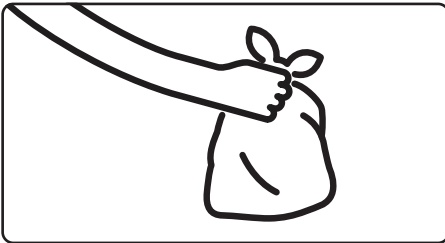

If you see something that obviously doesn't belong in the food scraps or recycling container, remove it.

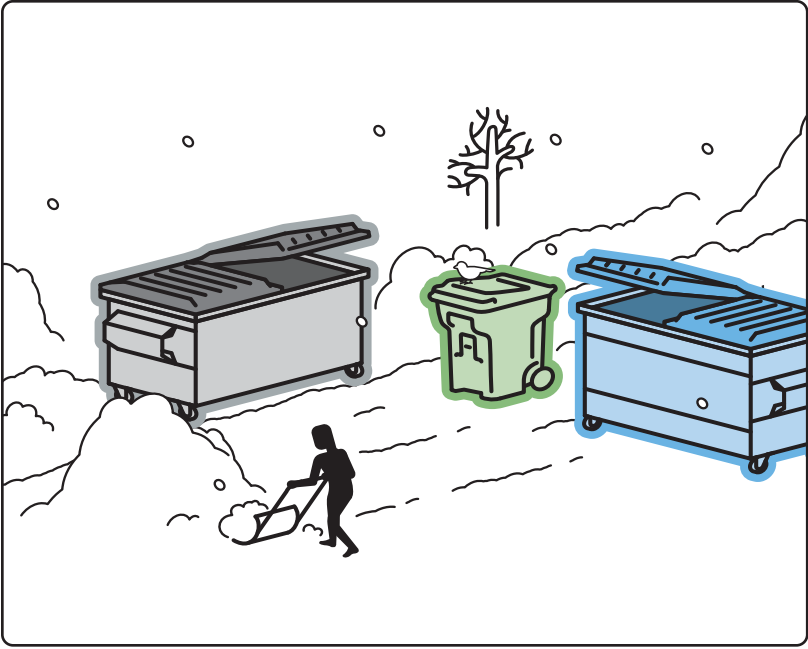

Keep the areas around bins, carts and doors clean and clear of snow, ice, vehicles, large items, bags and loose garbage.

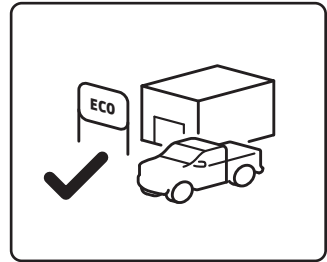
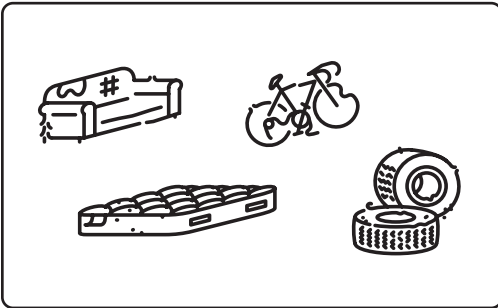

Remove and dispose of large or illegally dumped items by taking them to an Eco Station or calling a junk removal company.

Preventing and solving problems

.....

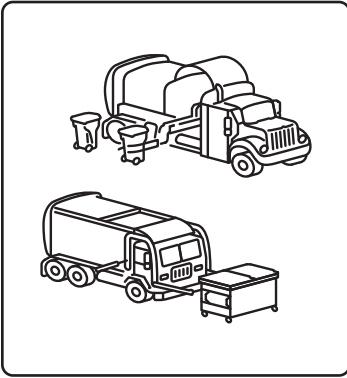

Waste not collected?

.....

Waste will not be collected if:

- Collectors cannot safely access and move the bins/carts
- There is too much contamination (such as too much food packaging in a food scraps cart, or bags of garbage in the recycling bin)

If bins are too contaminated, they can be collected as garbage, but fees may apply.

If carts/bins are accessible and not contaminated, report a missed collection by calling Waste Customer Support at **780-496-5698**.



Frozen food scraps

.....

Take these steps to help prevent food scraps from freezing onto surfaces:

- If you have carts, line them with bags
- Ask residents to put their food scraps in paper or plastic bags
- Gently loosen frozen food scraps with a shovel before collection

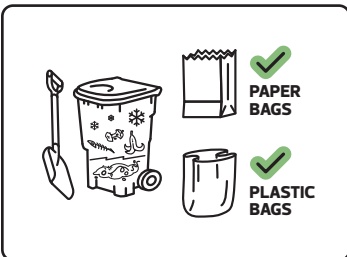

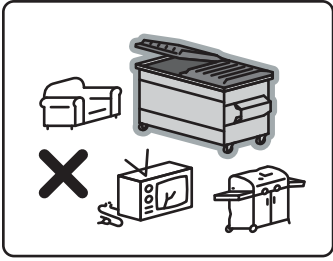

Illegal dumping

.....

Large items placed in or next to bins or carts will not be collected and may keep collectors from emptying them.

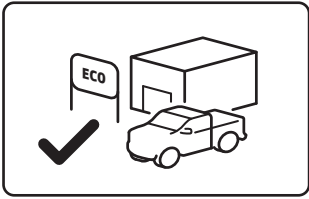

It is your responsibility to remove the items. Take the items to an Eco Station or call a junk collection company.

We are exploring factors leading to illegal dumping and developing best practices to help prevent it.

Learn more about illegal dumping and how to report it at edmonton.ca/IllegalDumping.

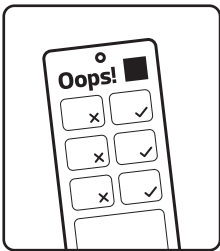

Oops tags

.....

If we can't empty your containers, we'll leave a tag explaining why. Please correct the problem and they will be emptied on the next collection day.

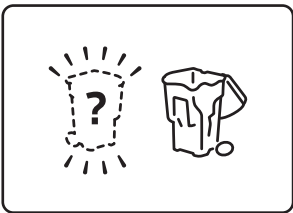

Missing carts

.....

Call Waste Customer Support at **780-496-5698** to report a missing cart and request a replacement.





Download the WasteWise app

WasteWise is a search tool that helps residents sort their recycling, food scraps and garbage.

Use it online at edmonton.ca/WasteWise, or download the free app from the Google Play or Apple App stores.



WasteWise is available in 14 languages.

English • čeština • Deutsch • Español
Français • Magyar • 日本語 • ភាសាខ្មែរ
한국어 • ਪੰਜਾਬੀ • Português • Русский
Tiếng Việt • 简体中文



FSC

www.fsc.org

100%

Paper from well-managed forests

FSC® C013747



edmonton.ca/Waste

Waste Collection at Apartments and
Condos · A Guide for Property Managers
Third Edition · August 2024

