



Volume 8: Manual for Pavement Marking Design

COE-IM-GUIDE-0014

v03



INTENT OF USE

This manual was developed for establishing standards for the City of Edmonton expectations in pavement marking design. Care has been taken to confirm the accuracy of the information contained herein. The views expressed herein do not necessarily represent those of any individual contributor. As the design of the assets and systems described herein continually evolves, and practices change and improve over time, so it is necessary to regularly consult relevant technical standards, codes, and other publications rather than relying on this publication exclusively. The City of Edmonton, authors, and members of the review committee, want to convey that this document does not constitute a project specific design. As such, no part of this manual alleviates the responsibility of the professionals retained to design and construct specific projects from taking full responsibility and authenticating their designs in accordance with APEGA, Transportation Association of Canada, Manual of Uniform Traffic Control Devices for Canada, Alberta Traffic Safety Act and associated Regulations, and any other statutory or safety requirements.

Any Standard Drawings, Details, or specifications herein are provided to convey the City's typically ideal general arrangement and requirements. Representations may not be to scale, they may be substantially schematic in nature and/or require further elaboration and development. As such those documents are not suitable for integration into a specific implementation without review and modification and are only intended for use by a competent designer exercising professional judgment. The designer shall modify and supplement as necessary to provide a complete, properly functioning design that conforms in all respects to the City's functional requirements. When actualized in a particular implementation it is the designer's responsibility to ensure the size, location, and spacing of all elements, and all components/specifications, are suitable and safe for the use and location intended, and any applicable code, legislative, and authority requirements are adhered to. In addition, any accessibility, operational and maintenance requirements must be met. Deviations from the represented nominal design parameters, questions of intent or accuracy, or any other apparent conflicts, shall be reconciled with an appropriate City representative. Finally, when employing any aspect of these documents, the ultimately responsible professional designer shall remove any authentication of the original author(s), note any provenance as appropriate, and apply their own authentication as required.



Professional Work Product (PWP) Authentication Table		
Responsible for all sections with the exception of Construction Specifications specifically referenced below	Darryl Mullen, P.Eng. General Supervisor Traffic Control and Parking	
Construction Specifications Section 7: 02760, 02761, 02762, 02763, 02764, 02765, 02767, 02768	Cherie Fuchs, P.Eng. General Supervisor Construction Materials Engineering and Testing	
Permit to Practice - Entire Document including Specifications	Janis Chow, P.Eng. General Supervisor Signals and Street Lighting	



Contact Information

The [latest version](#) of this document may be obtained in electronic format from the City of Edmonton Website.

Input to the progressive updating of this document is invited. Please direct any comments to:

General Supervisor, Traffic Control and Parking
Traffic Operations
Parks and Roads Services
City Operations
16th Floor, Edmonton Tower
10111 – 104 Avenue
Edmonton, AB T5J 0J4
trafficops@edmonton.ca

VER	Date	Revision Summary
01	January 1998	Original Issue
02	January 2010	Wording updates, addition of various bicycle facility symbols (i.e. sharrows, bike symbol, bike lane arrows)
03	2022-02-03	Wording updates and minor clarifications, change to 20 cm standard crosswalk line weight, addition of non-elongated bicycle symbol, clarification on guide line colours, removal of some drawings no longer in use (i.e. speed limit ahead symbol, pedestrian crossing ahead symbol, transit loop maker, road markings for full time contra-flow reserved lane). Change to document title.

TABLE OF CONTENTS

	PAGE
INTRODUCTION	7
1.0 LONGITUDINAL MARKINGS	8
1.1 DIRECTIONAL DIVIDING LINES	8
1.2 LANE LINES	9
1.3 PAVEMENT EDGE LINES	10
1.4 RESERVED LANE PAVEMENT MARKINGS	10
1.5 GUIDE LINES	11
1.6 REVERSIBLE LANE PAVEMENT MARKINGS	12
1.7 TWO - WAY LEFT TURN LANES	12
FIGURE 1.1 LINE TYPES	13
FIGURE 1.2 LANE AND LEAD - IN LINES	14
FIGURE 1.3 PAVEMENT EDGE LINES AT YIELDS AND MERGE ENTRANCES	15
FIGURE 1.4 PAVEMENT EDGE LINES AT EXITS	16
FIGURE 1.5 PAVEMENT EDGE LINES AT ON - OFF AUXILIARY LANES	17
TABLE 1 RESERVED LANE PAVEMENT MARKINGS	18
FIGURE 1.6.1 ROAD MARKINGS FOR FULL TIME WITH - FLOW RESERVED LANE	19
FIGURE 1.6.3 ROAD MARKINGS FOR PART TIME WITH - FLOW RESERVED LANE	20
FIGURE 1.6.4 RESERVED LANE INTERSECTION LINE DETAIL	21
FIGURE 1.6.5 DIAMOND SYMBOL DETAIL	22
FIGURE 1.7 GUIDE LINES	23
FIGURE 1.8 PAVEMENT MARKING FOR REVERSIBLE LANES	24
FIGURE 1.9 TWO - WAY LEFT TURN LANE	25
2.0 LATERAL MARKINGS	26
2.1 PEDESTRIAN CROSSWALKS	26
2.1.1 STANDARD CROSSWALKS	26
2.1.2 ZEBRA STRIPE CROSSWALKS	27
2.2 STOP LINES	28
2.3 STOP BOXES	29
FIGURE 2.1 LATERAL PAVEMENT MARKINGS	30
FIGURE 2.3 TYPICAL CROSSWALK AT INTERSECTION WITH PEDESTRIAN ACTUATED SIGNALS	31
FIGURE 2.4 TYPICAL CROSSWALK AT INTERSECTION, MIDBLOCK AND T - INTERSECTION WITH PEDESTRIAN FLASHER AND / OR SIGNS	32
FIGURE 2.5 TYPICAL CROSSWALK AT SIGNALIZED INTERSECTION	33
FIGURE 2.6 TYPICAL ARTERIAL ZEBRA STRIPE CROSSWALK DETAIL	34

FIGURE 2.7	TYPICAL 11 METER WIDE COLLECTOR ZEBRA STRIPE CROSSWALK DETAIL	35
FIGURE 2.8	TYPICAL 14 METER WIDE COLLECTOR ZEBRA STRIPE CROSSWALK DETAIL	36
FIGURE 2.14	STOP LINES AT RAILWAY CROSSING	37
FIGURE 2.15	TYPICAL STOP BOX PAVEMENT MARKING	38
3.0	MERGING AND DIVERGING AREAS	39
3.1	GORE AREAS	39
3.2	CONTINUITY LINES	41
3.3	MULTIPLE LANE ENTRY / EXIT	41
3.3.1	ENTRY	41
3.3.2	EXIT	41
FIGURE 3.1	DIVERGE AREA OPPOSING FLOW	42
FIGURE 3.2	DIVERGE AREA COMMON FLOW	43
FIGURE 3.3	MERGE AREA	44
FIGURE 3.4	EMERGENCY AREA (REQUIRED IF 'L' IS LESS THAN 'La')	45
FIGURE 3.5	CONTINUITY LINES	46
FIGURE 3.6	LEFT TURN BAY MARKINGS WITH SLAB - ON ISLAND	47
FIGURE 3.7	TWO LANE ENTRY AND EXIT	48
FIGURE 3.8	TWO LANE EXIT ON RIGHT WITH OPTIONAL USE	49
FIGURE 3.9	TWO LANE EXIT ON RIGHT ONLY	50
FIGURE 3.10	TWO LANE EXIT - FORCED RIGHT WITH THROUGH RIGHT OPTION	51
FIGURE 3.11	TWO LANE EXIT - FORCED RIGHT WITH THROUGH RIGHT OPTION	52
FIGURE 3.12	APPROACHES TO SIGNALIZED INTERCHANGE INTERSECTIONS	53
FIGURE 3.13	GORE DETAIL FOR MERGING / DIVERGING AREAS	54
4.0	SYMBOLS AND LETTERS	55
4.1	ARROWS	55
4.1.1	THROUGH ARROWS	55
4.1.2	LEFT OR RIGHT TURN ARROWS	56
4.1.3	THROUGH - LEFT OR THROUGH - RIGHT OPTION ARROWS	56
4.1.4	MERGE ARROWS	56
4.2	BICYCLE SYMBOL	56
4.3	SHARED USE LANE SYMBOL (SHARROWS)	57
4.4	RESERVED BICYCLE LANE DIAMOND	57



4.5	BICYCLE LANE ARROW	57
FIGURE 4.1	SPACING OF TURN ARROWS	58
FIGURE 4.2	SPACING OF RIGHT TURN ARROWS IN FORCED RIGHT TURN LANE	59
FIGURE 4.3	SPACING OF LEFT TURN ARROWS IN FORCED LEFT TURN LANE	60
FIGURE 4.4	DIMENSIONS FOR SINGLE ARROW	61
FIGURE 4.5	DIMENSIONS FOR DOUBLE ARROW	62
FIGURE 4.6	DIMENSIONS FOR MERGE ARROW	63
FIGURE 4.7	NON-ELONGATED BICYCLE SYMBOL	64
FIGURE 4.8	ELONGATED BICYCLE SYMBOL	65
FIGURE 4.9	BICYCLE SHARED USE “SHARROW” LANE SYMBOL	66
FIGURE 4.10	BICYCLE RESERVED LANE DIAMOND	67
FIGURE 4.11	BICYCLE LANE STRAIGHT ARROW	68
FIGURE 4.12	BICYCLE LANE TURN ARROW	69
FIGURE 4.13	BICYCLE LANE DOUBLE ARROW	70
5.0	SPECIAL SITUATIONS	71
5.1	TRAFFIC CIRCLES	71
5.2	PRIVATE DEVELOPERS	71
5.3	PARK TRAILS	71
5.4	RUMBLE STRIPS	72
FIGURE 5.1	TYPICAL TRAFFIC CIRCLE MARKING	73
FIGURE 5.2	RUMBLE STRIP DETAIL	74
6.0	MATERIAL INSTALLATION	75
6.1	DEFINITION	75
6.2	APPROVALS	75
6.3	CONTACT	75
6.4	NEW INSTALLATIONS	75
6.4.1	GENERAL RULES	75
6.4.2	ARTERIAL ROADS	75
6.4.3	COLLECTOR AND LOCAL ROADS	76
6.4.4	ARROWS, WORDS AND SYMBOLS	76
6.5	MAINTENANCE	76
6.5.1	HOT INLAID PLASTIC	76
6.5.2	SURFACE APPLIED PLASTIC	76
6.5.3	PATCH PAVING LOCATIONS	76
7.0	CONSTRUCTION SPECIFICATIONS	77

Manual for Pavement Marking Design

INTRODUCTION

The principles and standards governing pavement marking application are set out in the Transportation Association of Canada's Canadian Manual of Uniform Traffic Control Devices. The information in this document incorporates recent marking standards and includes several unique local conditions.

Five categories of pavement marking are discussed:

1. Longitudinal Markings
2. Lateral Markings
3. Merging / Diverging Areas
4. Symbols and Letters
5. Special Situations

It is important to note that the information presented in this manual may be altered for unusual traffic conditions. However, such special situations should be considered exceptions to the rule. Engineering judgment and practical experience are necessary supplements to the use of this manual.

Users of this document are assumed to have a basic understanding of traffic engineering terms and be able to recognize the related traffic movements.

The City of Edmonton Manual for Pavement Marking Design should be used as a first reference. Where no specific information is provided, the Canadian guidelines are to be used. Where a conflict between the Edmonton and the Canadian direction exists, the Edmonton approach should be applied.

1.0 LONGITUDINAL MARKINGS

Longitudinal markings are lines along the length of the roadway indicating to the driver their proper position on the roadway.

Areas discussed in this section include:

- 1.1 Directional Dividing Lines
- 1.2 Lane Lines
- 1.3 Pavement Edge Lines
- 1.4 Reserved Lane Markings
- 1.5 Guide Lines
- 1.6 Reversible Lane Pavement Markings
- 1.7 Two - Way Left Turn Lanes

The names and dimensions of each specific type of line are shown in Figure 1.1.

1.1 DIRECTIONAL DIVIDING LINES

Directional dividing lines are used to designate the traffic flows traveling in opposing directions.

The directional dividing line shall be 10 cm in width and yellow in color.
See Figure 1.1.

Directional dividing lines shall be applied:

- throughout the entire length of pavement on all arterial roadways and all collector roadways of 14 m or more in width.
- at approaches to fully signalized intersections and to multi - way stop intersections where the road is 11.5 m or more in width; extending back from the stop line for a distance of 30 m. See Figure 1.2.
- the entire length of pavement adjacent to elementary school sites with an operating elementary school within playground zones if the roadway is 11.5m or more in width.

Directional dividing lines may also be placed on collector roads of less than 14 m in width where geometric conditions and specific transit requirements warrant increased guidance to the motorist.

Typical examples of collector road conditions where additional guidance may be provided include:

- a. Pavement width transitions.
- b. Horizontal and vertical curves where sight distances do not conform to Transportation Association of Canada (TAC) stopping sight distance guidelines.

On most roadways, the directional dividing line will coincide with the geometric centre of the pavement surface. In some cases, however, the directional dividing line may be located in an off-centre position to make more efficient use of the roadway space. Typical examples of this exception are :

- a. Pavement width transitions.
- b. Added turning lanes at intersections.
- c. An uneven number of lanes in each travel direction.
- d. Zones with parking on one side of the roadway.

1.2 LANE LINES

Lane lines indicate and direct traffic into proper channels.

Lane lines shall be:

- white in color
- 10 cm in width
- in either 3 m long segments with 6 m gaps where lane changes are allowed, or solid throughout the length of lane change prohibition.

Lane Lines should be applied over the entire length of roadway where more than one travel lane in the same direction is present.

Lane Lines should be used as determined by Engineering analysis:

- throughout the entire length of pavement on all arterial and median divided collector roads and collector roadways of 14 m or more in width where parking is not permitted.
- on collector roads at approaches to signalized intersections where the pavement surface width allows for more than one travel lane.

Lane lines should extend back from the stop line for a minimum distance of 30 m.

See Figure 1.2.

1.3 PAVEMENT EDGE LINES

Pavement edge lines delineate the pavement edge or the shoulder from the travel lane.

Pavement edge lines if installed shall be:

- continuous white lines when placed on the right-hand side of the travel lane.
- continuous yellow lines when placed on the left-hand side of the travel lane.
- 10 cm in width, including right turn cut-offs and left turn bay islands, except at merging/diverging zones.
- 20 cm width at merging/diverging zones.

Pavement edge lines may be used at the following locations:

- where paved shoulders are present
- in merge and diverge zones
- at pavement width transitions
- at V-gutters
- where obstructions on the shoulder may be considered to constitute a hazard to the motorist in that lane.

For examples of standard applications of Pavement edge lines see Figures 1.3 to 1.5.

1.4 RESERVED LANE MARKINGS

Reserved lane pavement markings shall be used to identify lanes designated for use by only certain types of vehicles. Lanes reserved solely for bicycles are not covered by this section. The pavement markings (described in Table 1 and shown in Figures 1.6.1, 1.6.3, 1.6.4, and 1.6.5) consists of:

- a solid 20 cm wide white or yellow longitudinal line interrupted only at intersections with alleyways by a broken 20 cm yellow (if contra-flow) or white 0.5 m line (if with-flow) with a 0.5 m gap.
- a solid 20 cm wide white line for 30 m at the start of block, then broken to the end of block; with a 6 m line and 3 m gap for with-flow reserved lane where right turns are permitted.
- an angled broken line section at intersections where right turns are permitted from side streets across a full time with-flow reserved lane.

Along with

- an elongated diamond shape of 20 cm wide white lines for lane identification, to provide supplementary operational and regulatory information to the driver.
- diamond shape symbols must be used in conjunction with either a ground or overhead mounted sign for reserved lanes.
- diamond symbols shall be placed centered 10 m downstream from either the beginning of each block or from each crosswalk. Additional diamond symbols may be used depending on block length and major access points.
- additional diamond symbols may be used if right turns are not permitted from the reserved lane.
- additional diamond symbols shall be spaced 75 m to 100 m as required.
- diamond symbols shall be centered 10 m upstream from each intersection or crosswalk for contra-flow reserved lanes.

1.5 GUIDE LINES

Guide lines provide travel path guidance to drivers as they proceed through an intersection or merge into proper travel lanes.

Guide lines should be 10 cm in width, 0.5 m in length with 0.5 m gaps, and:

- white when connecting two lane lines, or
- yellow when on a driver's left-hand side and connecting a directional dividing line to a directional dividing line or a directional dividing line to a forced left turning lane line.

Guide lines shall be used at the following locations:

- where a multi-lane turn is present.
- where a turn lane would lead into a turn lane for the next, downstream, intersection.
- where the uphill/downhill roadway grade requires guide lines for improved traffic flow.
- where the roadway grade changes inside the intersection.
- at intersections where approaches are not at 90° to each other.
- at signalized intersections with lane control systems.
- at intersections between two-way and one-way streets.

See Figures 1.7 and 3.12.

1.6 REVERSIBLE LANE PAVEMENT MARKINGS

Reversible lane pavement markings shall be used to identify lanes that may be used exclusively by one travel direction for some specified period of the day and by the other travel direction during another specified period of the day.

Reversible lane markings shall be yellow, double, broken lines 10 cm in width. Broken line segments shall be 3 m long yellow lines with a 6 m gap. See Figures 1.1 and 1.8.

Reversible lane pavement markings shall be applied on both the right and the left-hand sides of the reversible lane throughout the entire length of the reversible lane. These markings shall be used in conjunction with reversible lane signals.

1.7 TWO-WAY LEFT TURN LANES

Two-way left-turn lanes shall consist of pavement markings:

- 10 cm in width.
- yellow in color.
- broken line segments, 3 m lines with 6 m gaps, on the inside of the lane.
- solid line segment on the outside of the lane.
- applied on both sides of the lane, except at designated left-turn lanes at intersections.

See Figures 1.1 and 1.9.

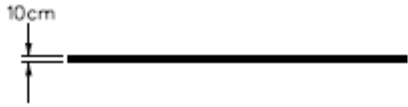
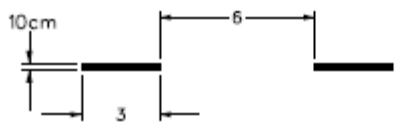
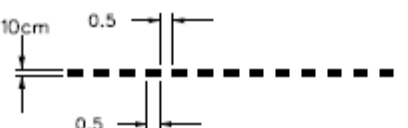


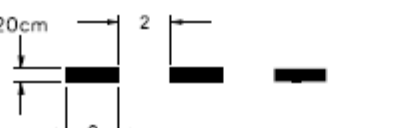
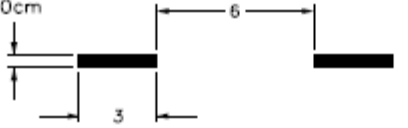
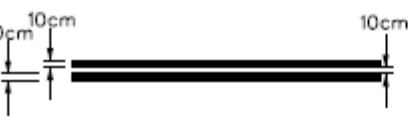
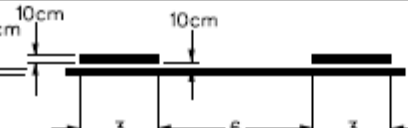
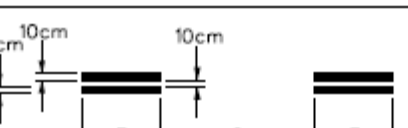
NAME OF LINE	DIMENSIONS (m)	USE
SOLID		-EDGE LINES (WHITE OR YELLOW), -DIRECTIONAL DIVIDING LINES (YELLOW), -LANE LINES PROHIBITING LANE CHANGES (WHITE)
BROKEN		-DIRECTIONAL DIVIDING LINES (YELLOW), -LANE LINES (WHITE)
DENSE BROKEN		-GUIDE LINES (eg. INTERSECTION MOVEMENTS) YELLOW OR WHITE
WIDE SOLID		-EDGE LINES IN CRITICAL AREAS (WHITE ON THE RIGHT, YELLOW ON THE LEFT)
WIDE BROKEN		-CONTINUITY LINES IN MERGING AND DIVERGING AREAS -SPECIAL FUNCTION LANE LINES
WIDE BROKEN		-CONTINUITY LINES IN MERGING AND DIVERGING AREAS AT MULTIPLE LANE ENTRY/EXIT
WIDE BROKEN		-CONTINUITY LINES IN MERGING AND DIVERGING AREAS -FORCED TURN LANE
DOUBLE SOLID		-DIRECTIONAL DIVIDING LINES (YELLOW) -LANE LINES WHERE LANE CHANGES FROM EITHER SIDE ARE PROHIBITED (WHITE)
SIMULTANEOUS SOLID AND BROKEN		-DIRECTIONAL DIVIDING LINES, TWO-WAY LEFT TURN LANES (YELLOW), -LANE LINES WHERE LANE CHANGES FROM ONE SIDE ARE PROHIBITED (WHITE)
DOUBLE BROKEN		-REVERSIBLE LANES (YELLOW)

Figure 1.1
 LONGITUDINAL LINE TYPES

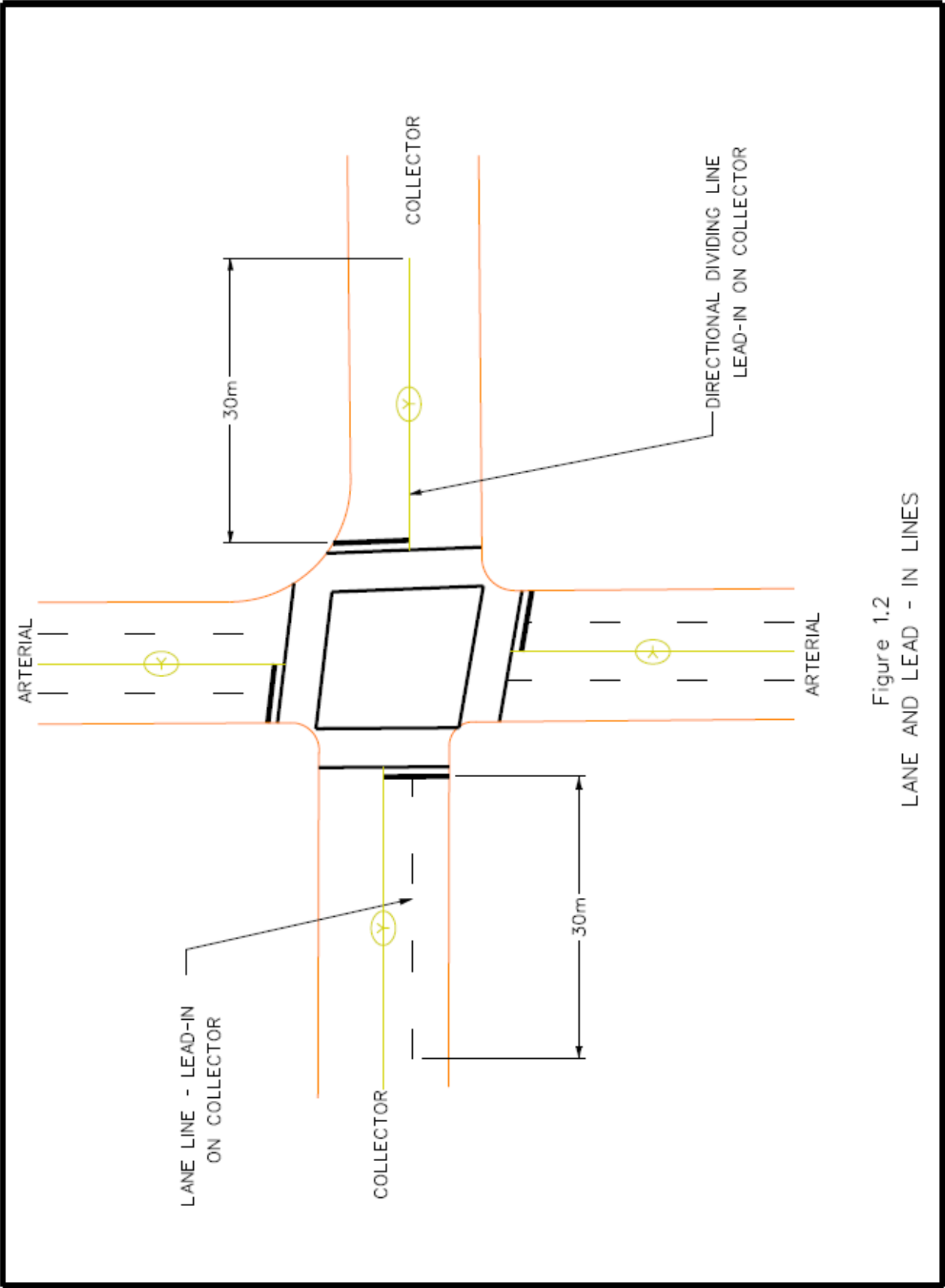
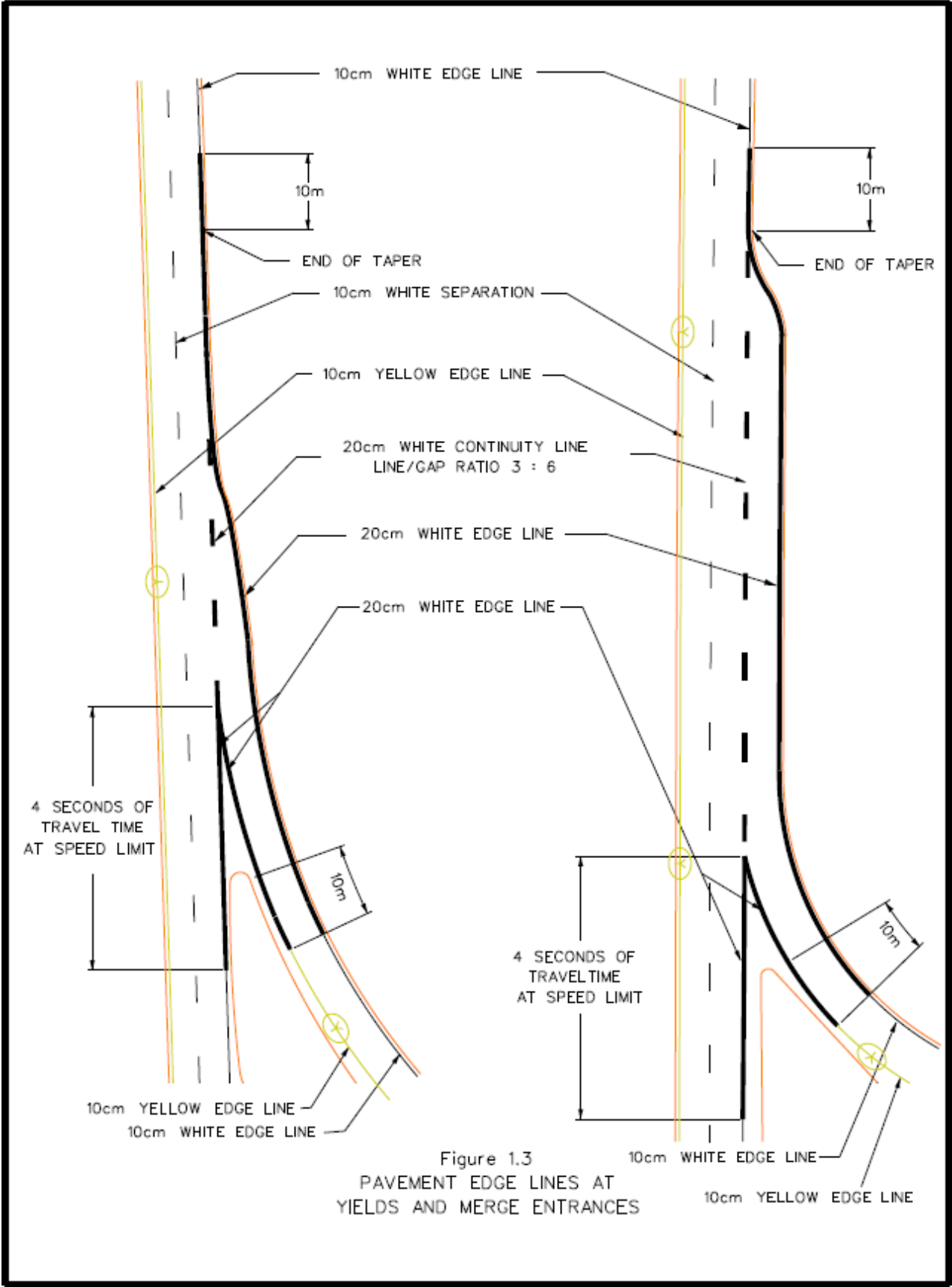
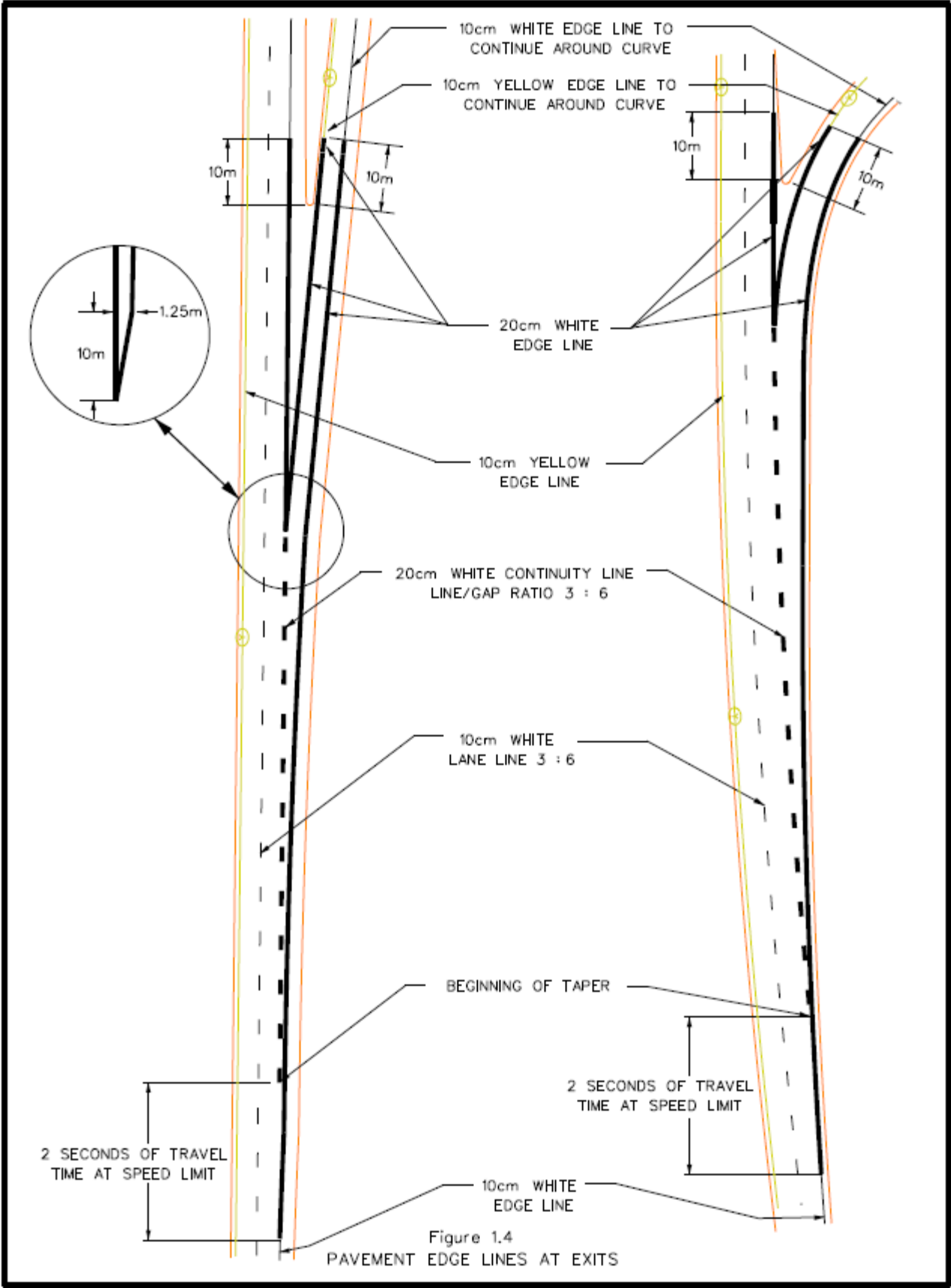


Figure 1.2
LANE AND LEAD - IN LINES





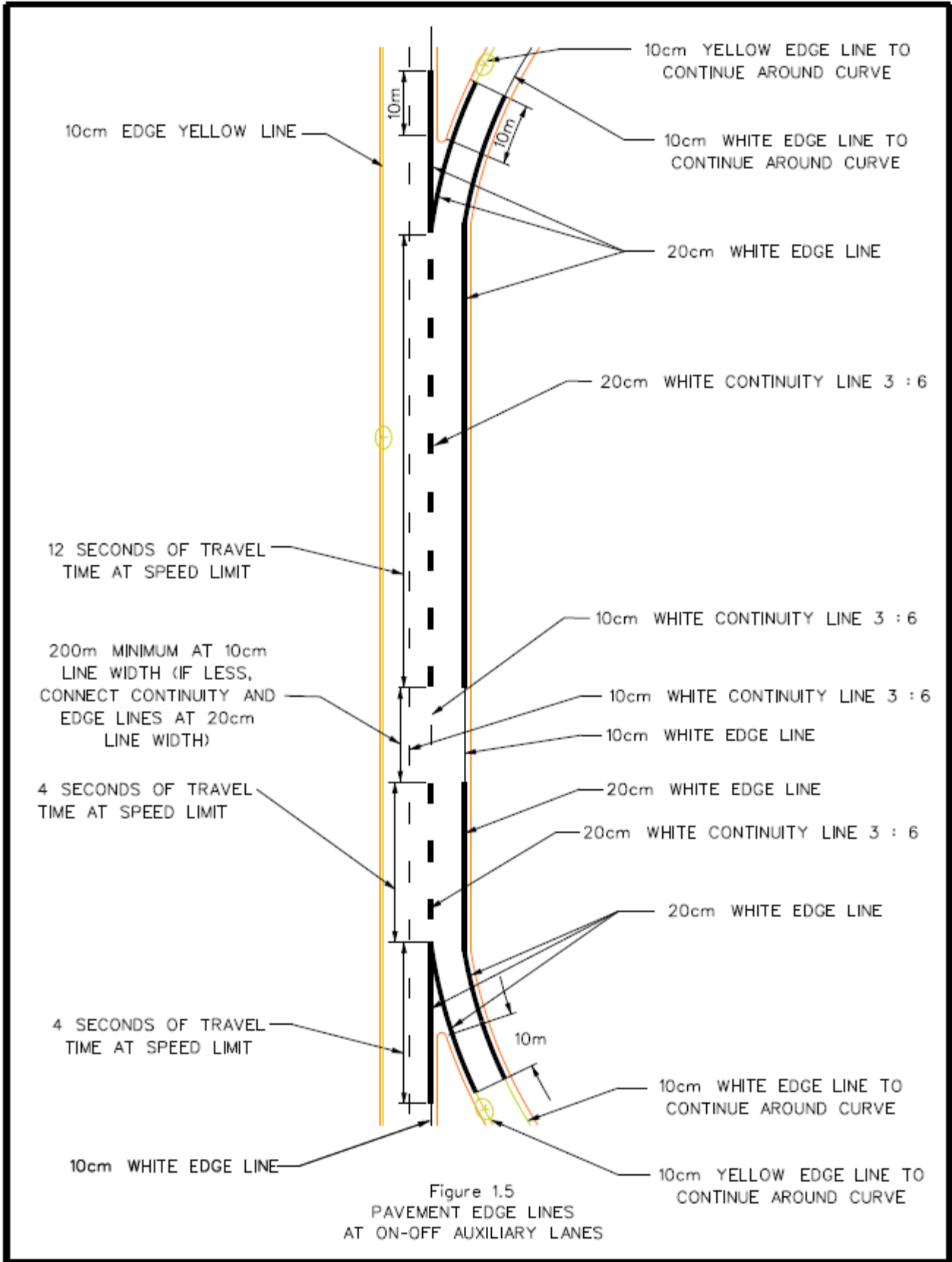


Figure 1.5
 PAVEMENT EDGE LINES
 AT ON-OFF AUXILIARY LANES

TABLE 1

RESERVED LANE PAVEMENT MARKINGS

Type of Reserved Lane	Diamond Symbols	Directional or Lane Lines	Intersection Lines for Right Turns
Full - Time With - Flow	Minimum Requirements: 1 centered 10 m from the start of each block or after each crosswalk. Additional diamond to be spaced 75 m to 100 m as required. See Figure: 1.6.1, 1.6.4, and 1.6.5.	Lane lines - White; 20 cm solid. Where right turns are permitted, solid for a minimum of 30 m and then broken with 6 m line and 3 m gap. See Figure 1.6.1.	Intersection Lines where right turns from side streets are permitted. See Figures 1.6.1 and 1.6.4.
Part - Time With - Flow	Minimum Requirements: 1 centered 10 m from the start of each block or after each crosswalk. Additional diamond to be spaced 75 m to 100 m as required. See Figure 1.6.3.	Lane Lines - white, standard 10 cm broken with 3 m line and 6 m gap. See Figure 1.6.3.	None

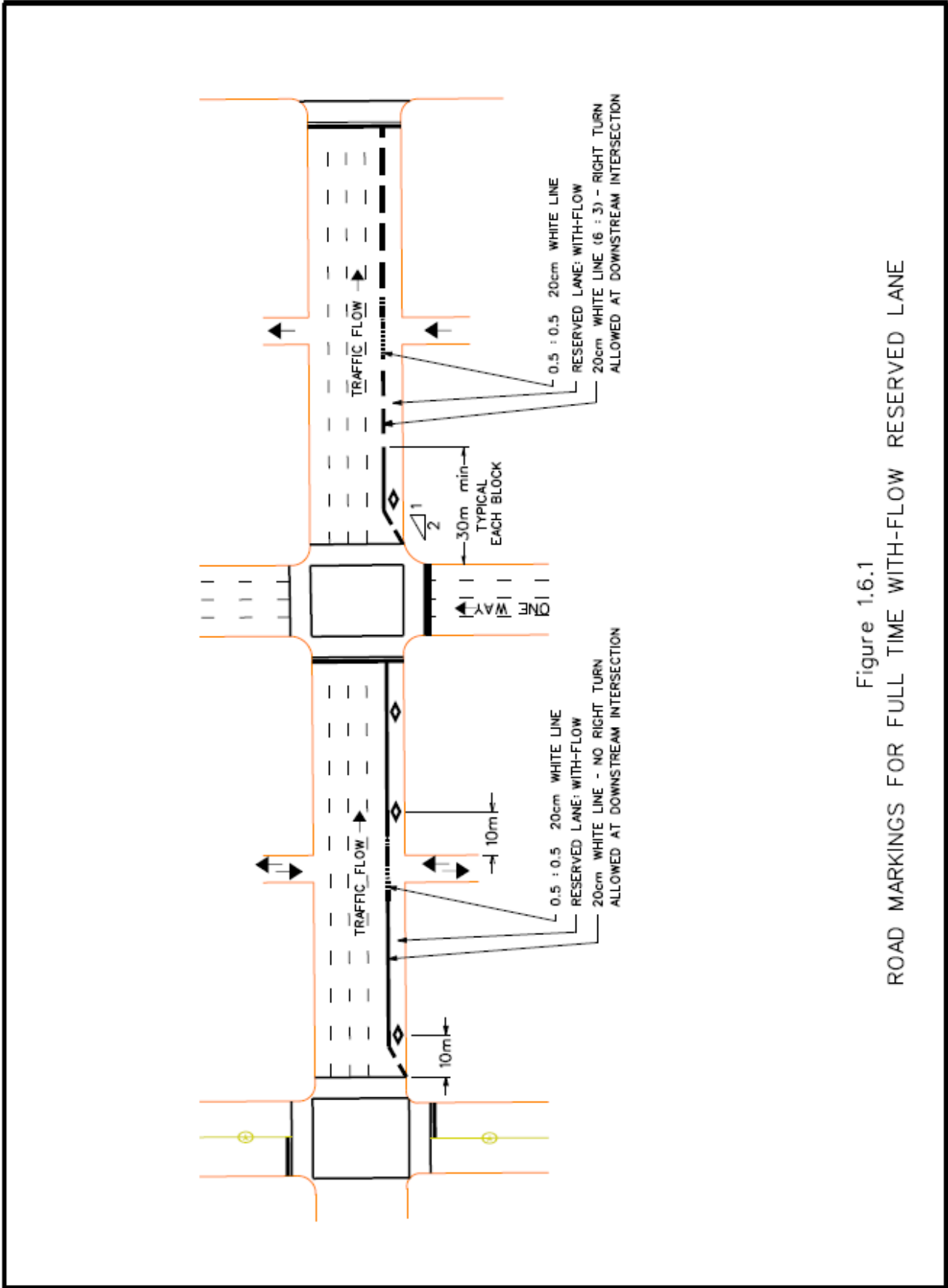
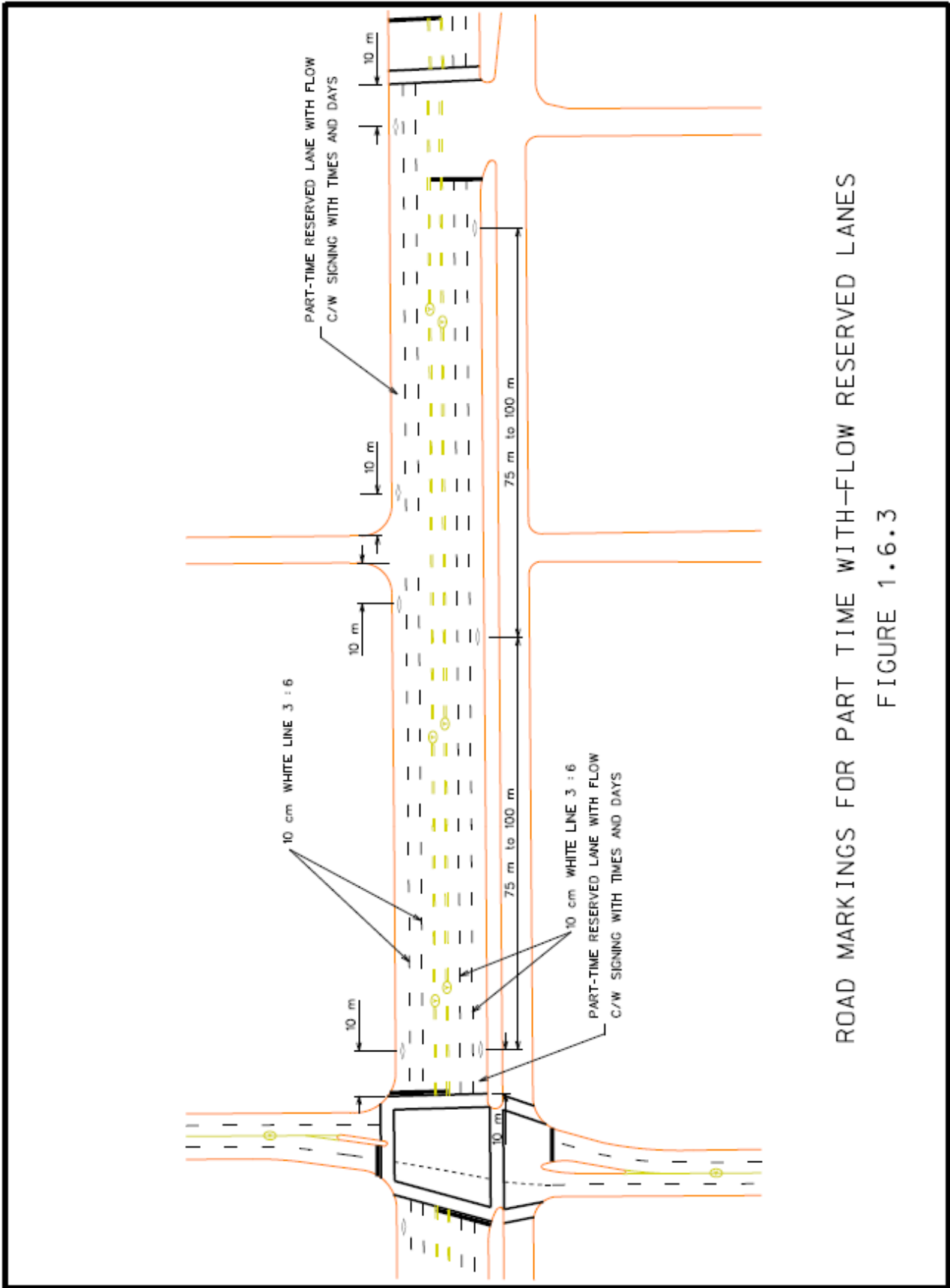
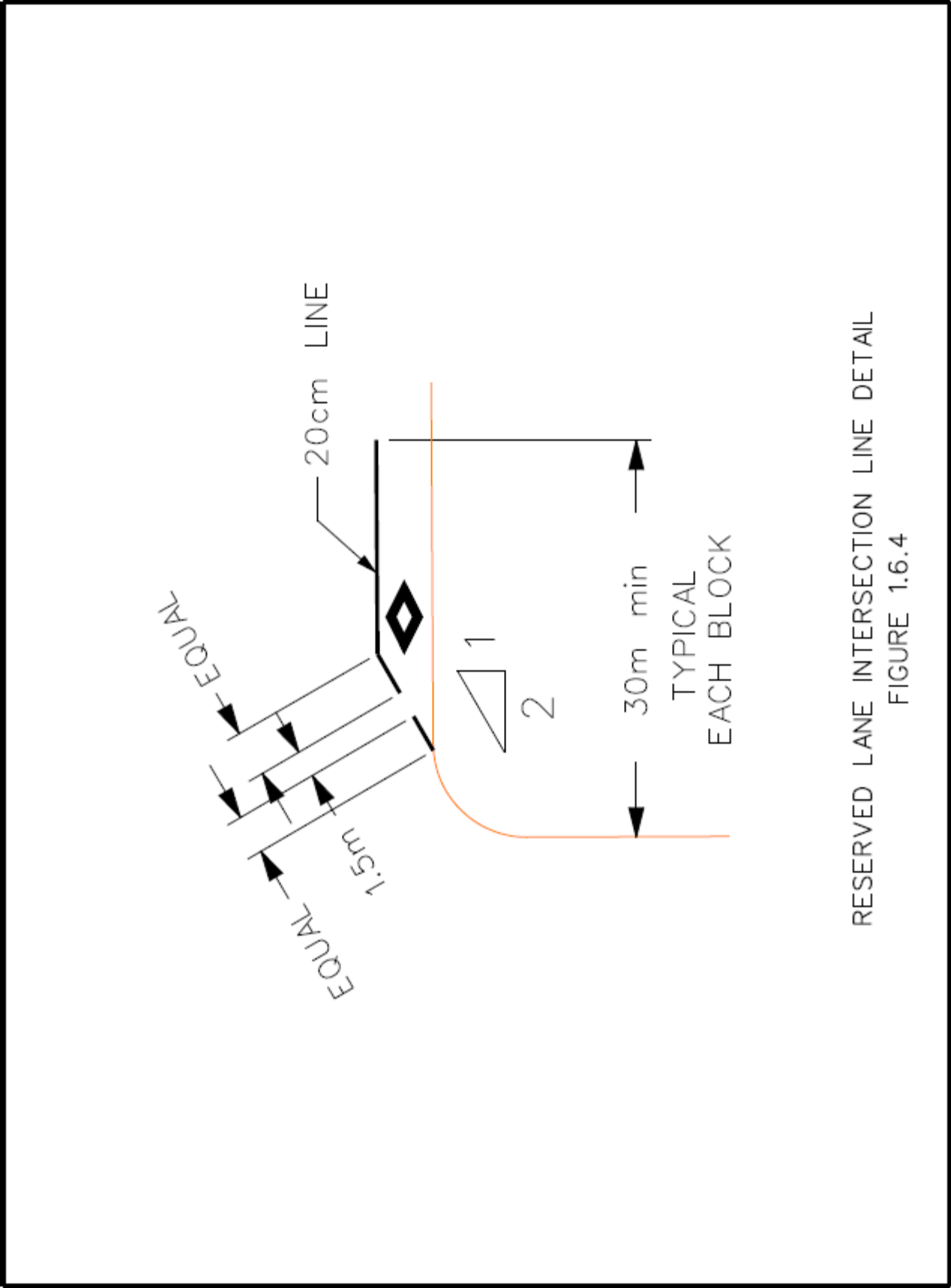
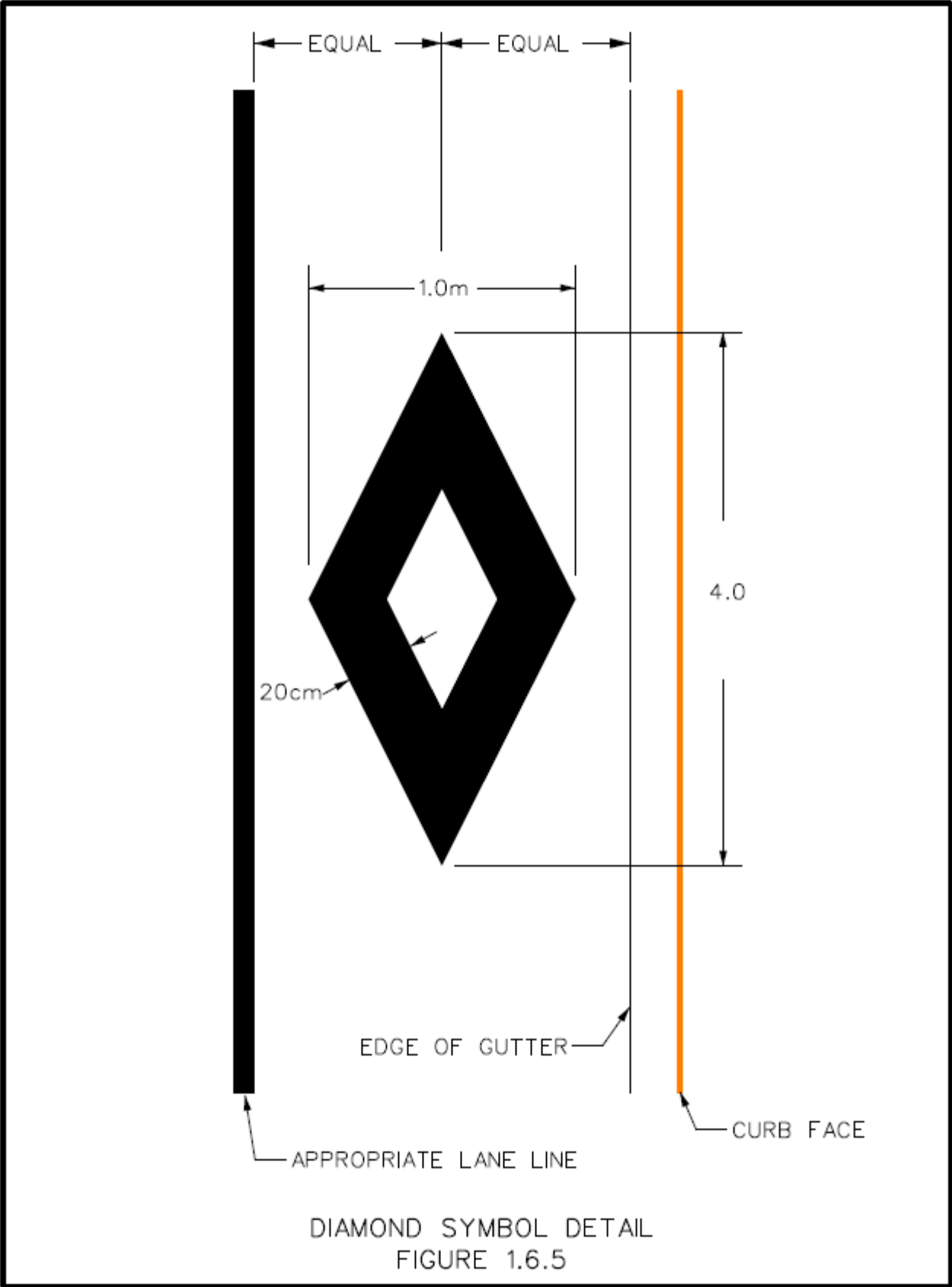


Figure 1.6.1
 ROAD MARKINGS FOR FULL TIME WITH-FLOW RESERVED LANE



ROAD MARKINGS FOR PART TIME WITH-FLOW RESERVED LANES
FIGURE 1.6.3





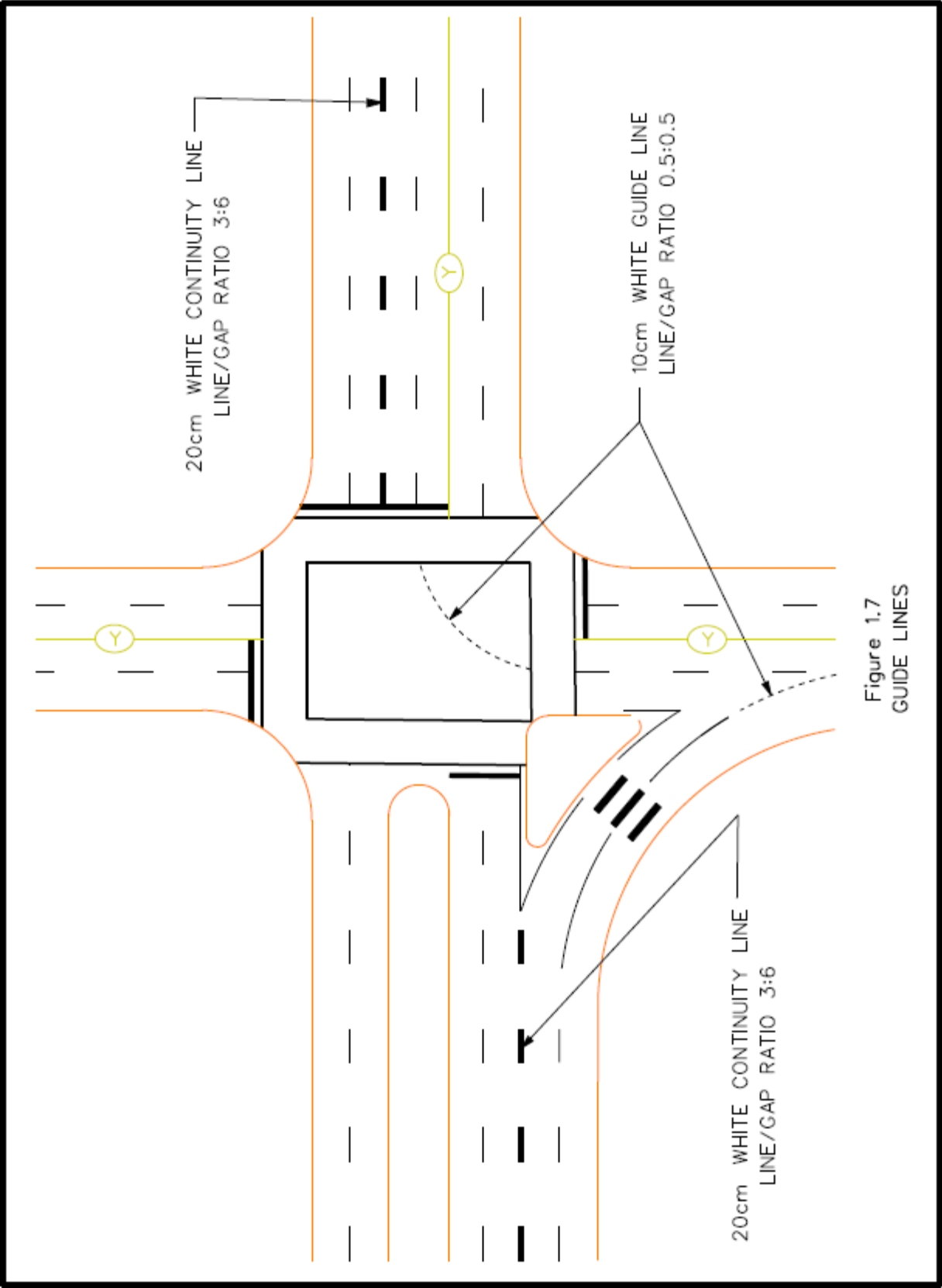
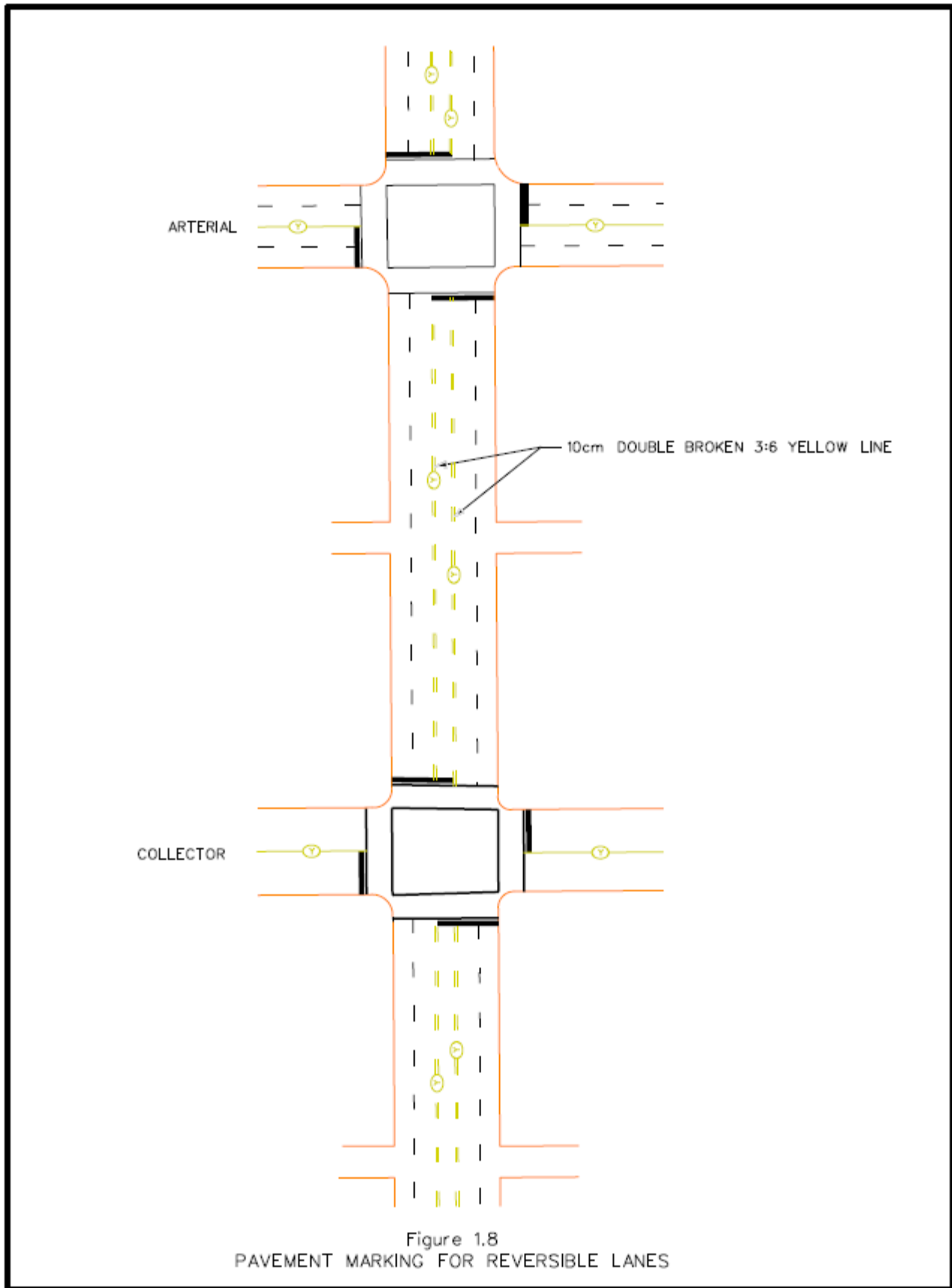
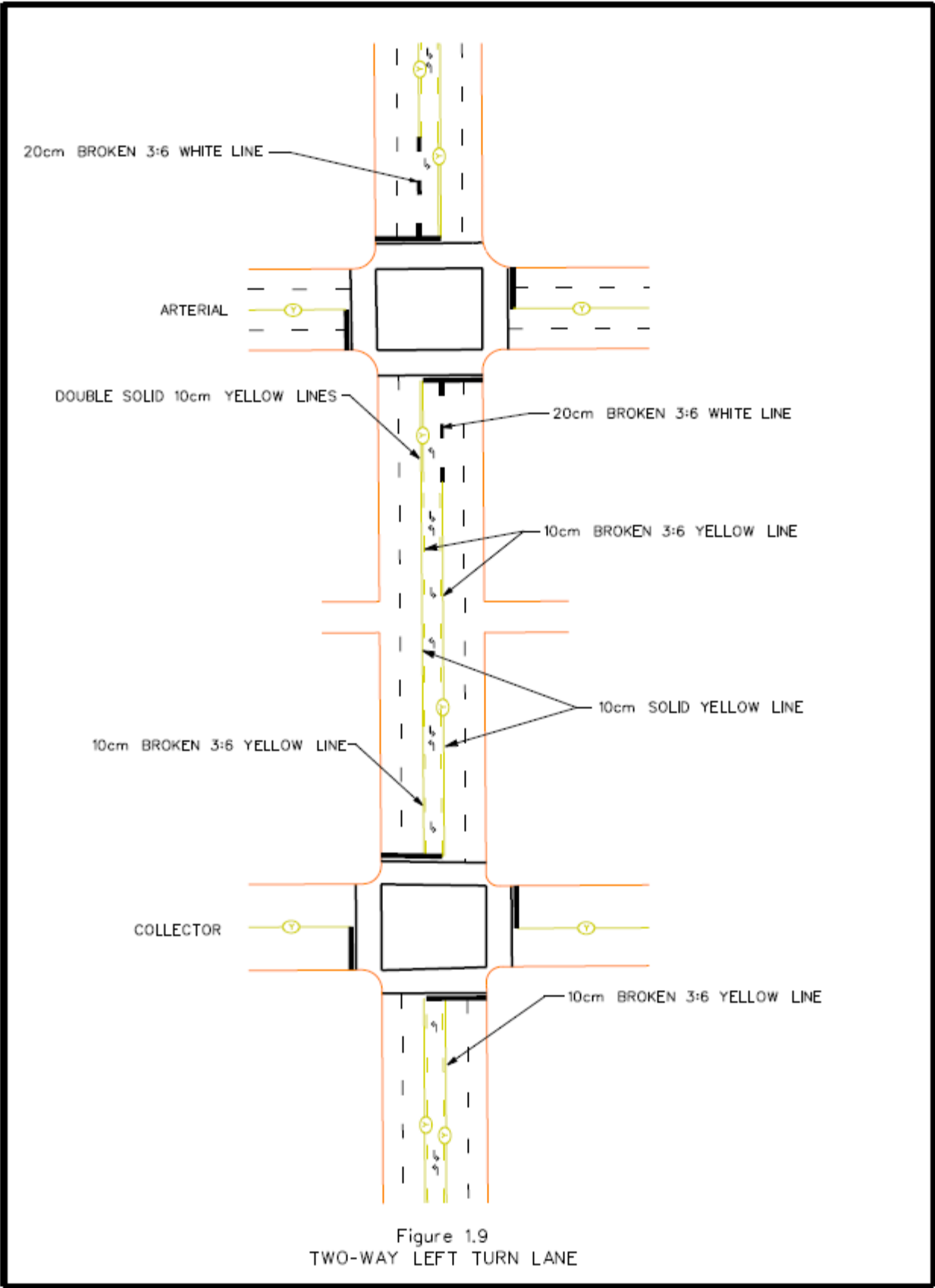


Figure 1.7
GUIDE LINES





2.0 LATERAL MARKINGS

Lateral pavement markings cross the road and indicate roadway crossing zones for pedestrians and vehicle stop location.

Three categories of lateral markings :

- 2.1 Pedestrian Crosswalks
 - 2.1.1 Standard Crosswalks (Parallel lateral lines)
 - 2.1.3 Zebra Stripe Crosswalks (Longitudinal lines)
- 2.2 Stop Lines
- 2.3 Stop Boxes

2.1 PEDESTRIAN CROSSWALKS

All intersections are legal points of crossing, unless the crossing is specifically banned. Pedestrian crosswalk lines are associated with a higher level of pedestrian control, and indicate a designated location where pedestrian crossing of the roadway is permitted, and are accompanied by other traffic control devices such as traffic signals, pedestrian signals, or crosswalk signage. All curb ramps should be centred in the crosswalk.

2.1.1 STANDARD CROSSWALKS

Parallel (Standard) pedestrian crosswalk lines passing across the roadway provide a basic form of traffic control device for the pedestrian.

Locations where standard crosswalk lines shall be painted on the pavement are :

- at full traffic signals.
- at pedestrian traffic signals.
- at multi-way stop controlled intersections with sidewalks or curb ramps.
- at other intersections with a high pedestrian volume as determined by the Safe Mobility Section.

A decorative crosswalk at any of the above locations does not remove the requirement for painted parallel crosswalk lines.

See Figures 2.1, 2.3, 2.4, and 2.5.

These lines shall be :

In all parts of the city except the Downtown area (or other areas as determined by the Safe Mobility Section):

- parallel lines 4 meters apart centerline to centerline of crosswalk lines.
- 20 cm in width.
- white in color.

In the Downtown area (or other areas as determined by the Safe Mobility Section)

- parallel lines 5 meters apart centerline to centerline of crosswalk lines.
- 20 cm in width.
- white in color.

The Downtown area is defined as the area enclosed by 95 Street to 109 Street between the North Saskatchewan River and 104 Avenue.

2.1.2 ZEBRA STRIPE CROSSWALKS

In the situations outlined below or based on engineering analysis, a zebra stripe pedestrian crosswalk may be installed to enhance the visibility of a marked crosswalk.

Zebra stripe pedestrian crosswalk markings shall be applied at:

- mid-block locations
- at right-turn cut-offs
- at intersections with pedestrian actuated flashers and rapid flashing beacons
- at arterial roundabouts
- at crosswalk locations adjacent to elementary school sites with an operating elementary school within playground zones
- at locations as determined by the Safe Mobility Section

The Zebra stripe pedestrian crosswalk lines shall be applied:

- on roads with a speed limit of 60 km/h or less:
 - parallel to the travel direction.
 - 60 cm in width.
 - 4 meters in length.
 - white in color.

See Figures 2.6, 2.7, and 2.8.

- on roads with a speed limit greater than 60 km/h or in the Downtown area (or other areas as determined by the Safe Mobility Section):

- parallel to the travel direction.
- 60 cm in width.
- 5 meters in length.
- white in color.

See Figures 2.1, 2.5, 2.6, 2.7 and 2.8.

2.2 STOP LINES

These markings shall be applied at :

- all signalized and multi-way stop controlled intersections.
- protected railroad crossings (Figure 2.14).
- at other intersections where engineering analysis warrants their application.

The stop line shall be :

- white in color.
- 30 cm in width.
- installed over the entire width of the travel lanes approaching the intersection.
- installed 1 meter from the centerline of the near side of the pedestrian crosswalk, intersecting curb-face if no sidewalk is present, or the near side of the intersecting sidewalk.
- at railway crossings, the stop line shall be placed 2 meters in front of the railway warning device in the direction of travel and a minimum of 5 meters from the nearest rail. Where the dimensions cannot both be met, 5 meters from the nearest rail shall apply. See Figure 2.14.

At pedestrian actuated crosswalk signals, the stop line shall be installed as shown in Figures 2.1 and 2.3.

2.3 STOP BOXES

Stop boxes may be painted on approaches to signalized intersections where the potential for vehicle movement conflicts exist and where circumstances dictate a need for them.

The lines used to mark the stop box shall be :

- 10 cm in width.
- white in color.
- laterally defined by the yellow roadway centerline and curb or adjacent lane line.
- longitudinally defined by the near side of the crosswalk and the stop line.
- two intersecting diagonal lines inside the stop box.

Stop boxes should have a length of not less than 6 meters between the stop line and the near side of the pedestrian crosswalk (determined by the appropriate TAC design vehicle turning vehicle template).

See Figure 2.15.

Some multi-lane roads may require staggered stop boxes or a stop box for the inside lane only, rather than one single stop box across all lanes. Traffic movement conditions at the intersection should be considered in determining the appropriate stop box arrangement.

NAME	BASIC PATTERN	APPLICATION - WHITE	NUMBER
SOLID STRIPE 10 cm		STOP BOX : TWO CROSSED SOLID STRIPES	①
SOLID STRIPE 20 cm		CROSSWALK : TWO PARALLEL SOLID STRIPES	②
SOLID STRIPE 30 cm		STOP LINE : ONE SOLID STRIPE	③
SOLID STRIPE 60 cm		ZEBRA STRIPE CROSSWALK :	④

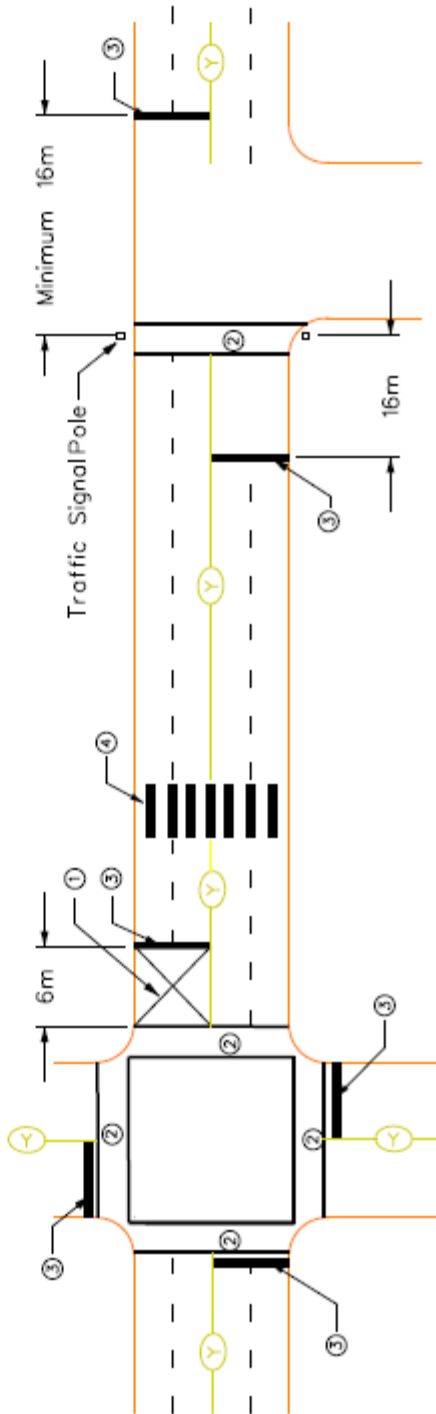


Figure 2.1
 LATERAL PAVEMENT MARKINGS

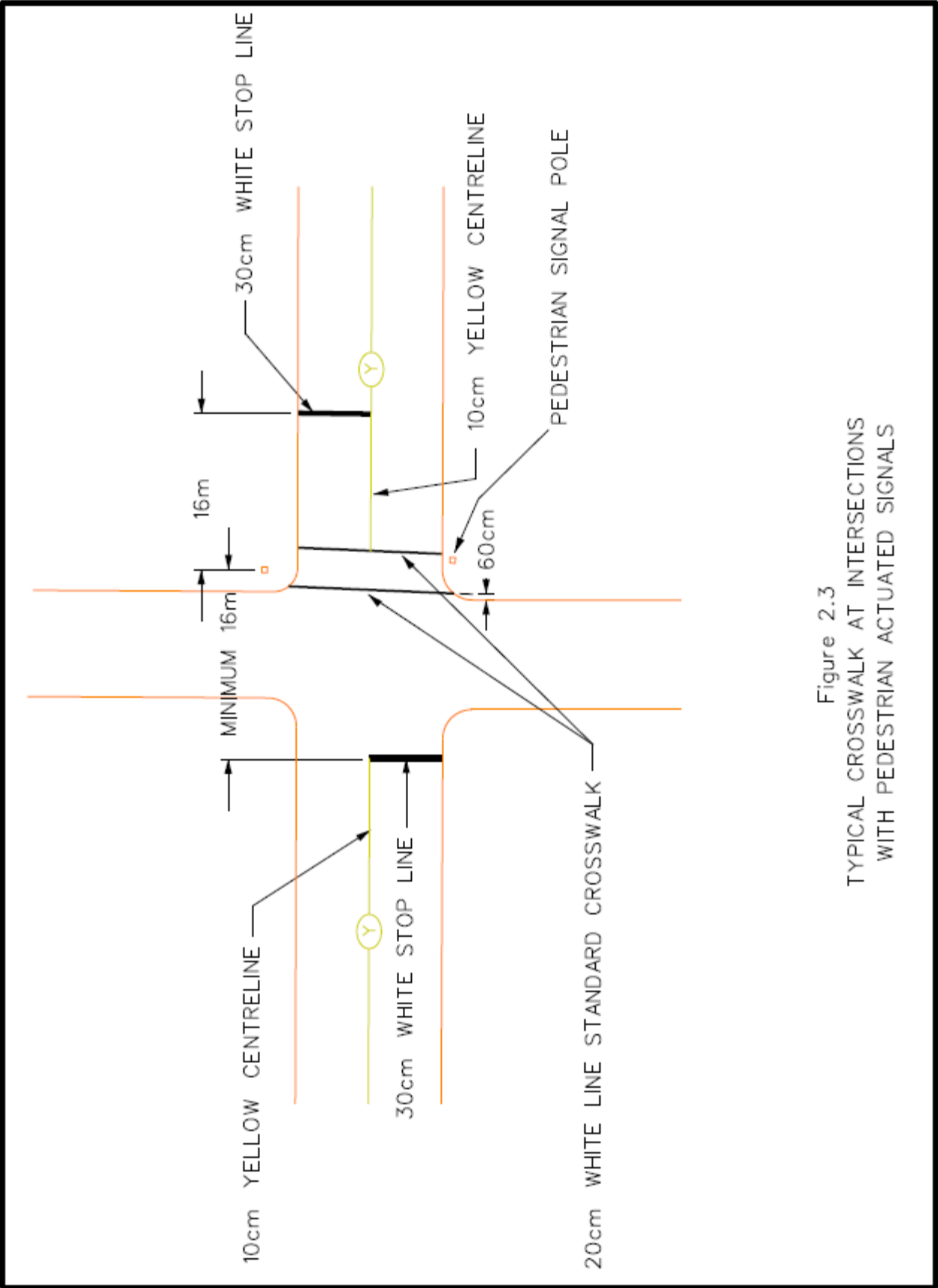


Figure 2.3
 TYPICAL CROSSWALK AT INTERSECTIONS
 WITH PEDESTRIAN ACTUATED SIGNALS

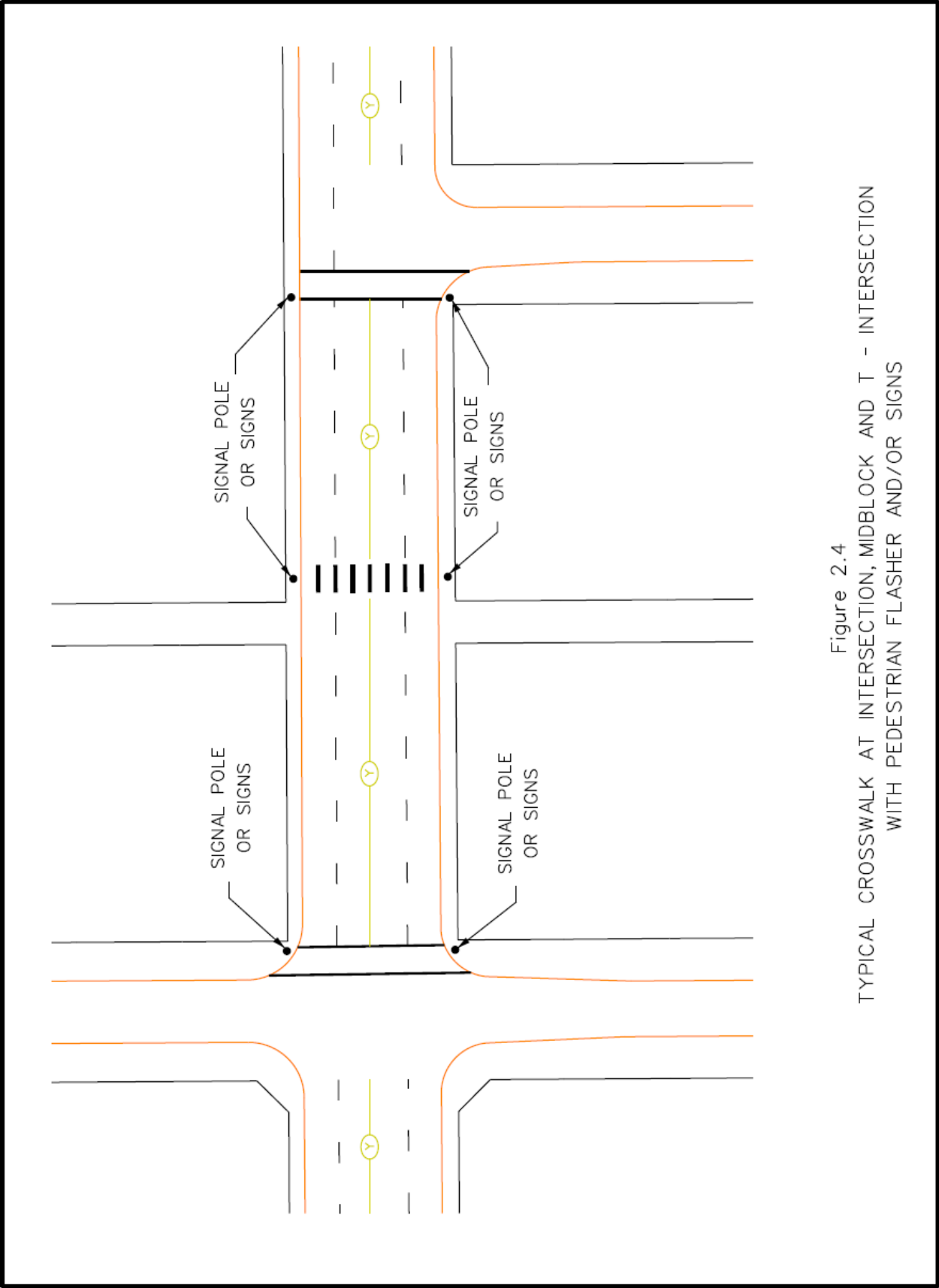


Figure 2.4
TYPICAL CROSSWALK AT INTERSECTION, MIDBLOCK AND T - INTERSECTION
WITH PEDESTRIAN FLASHER AND/OR SIGNS

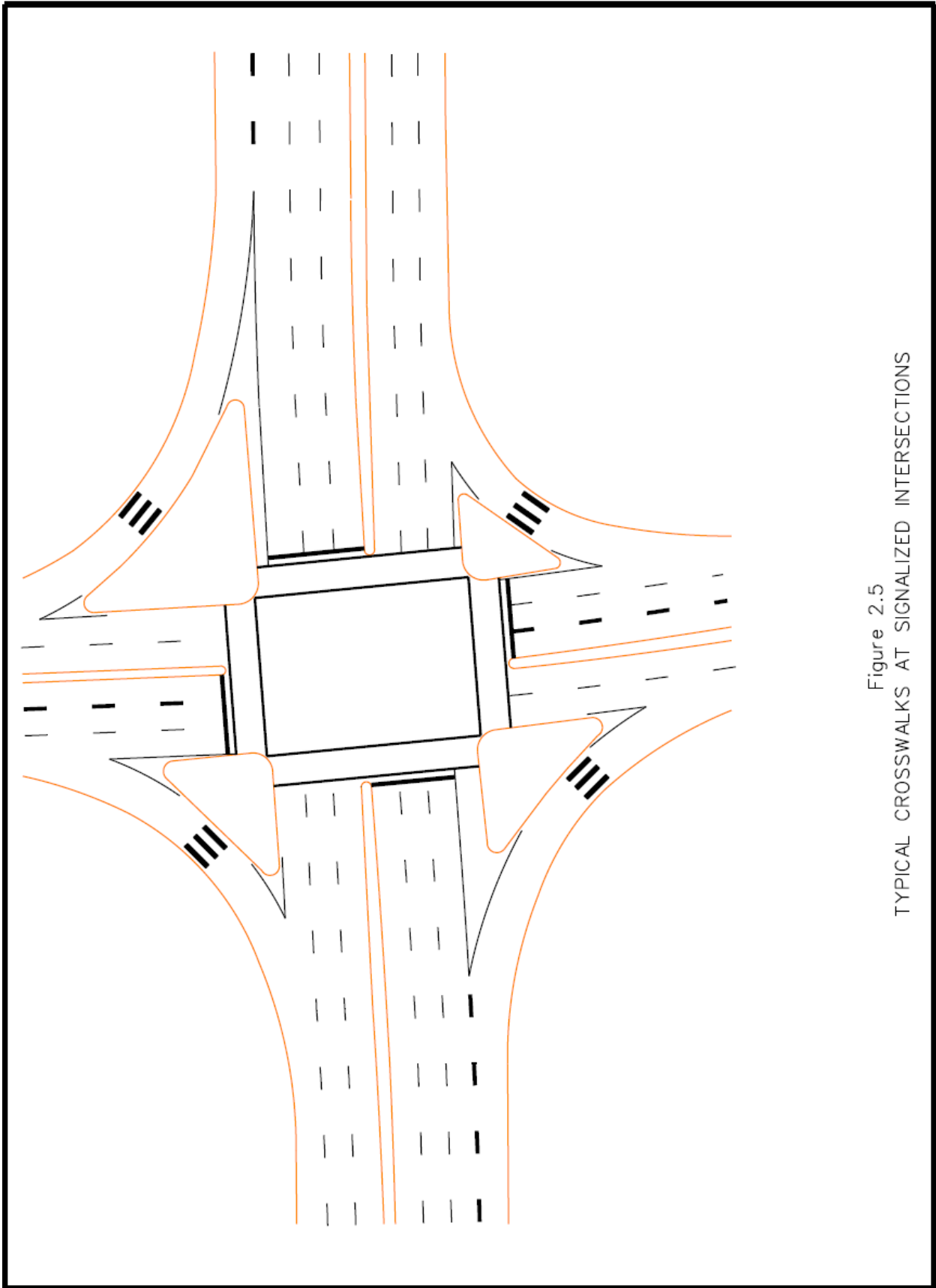


Figure 2.5
TYPICAL CROSSWALKS AT SIGNALIZED INTERSECTIONS

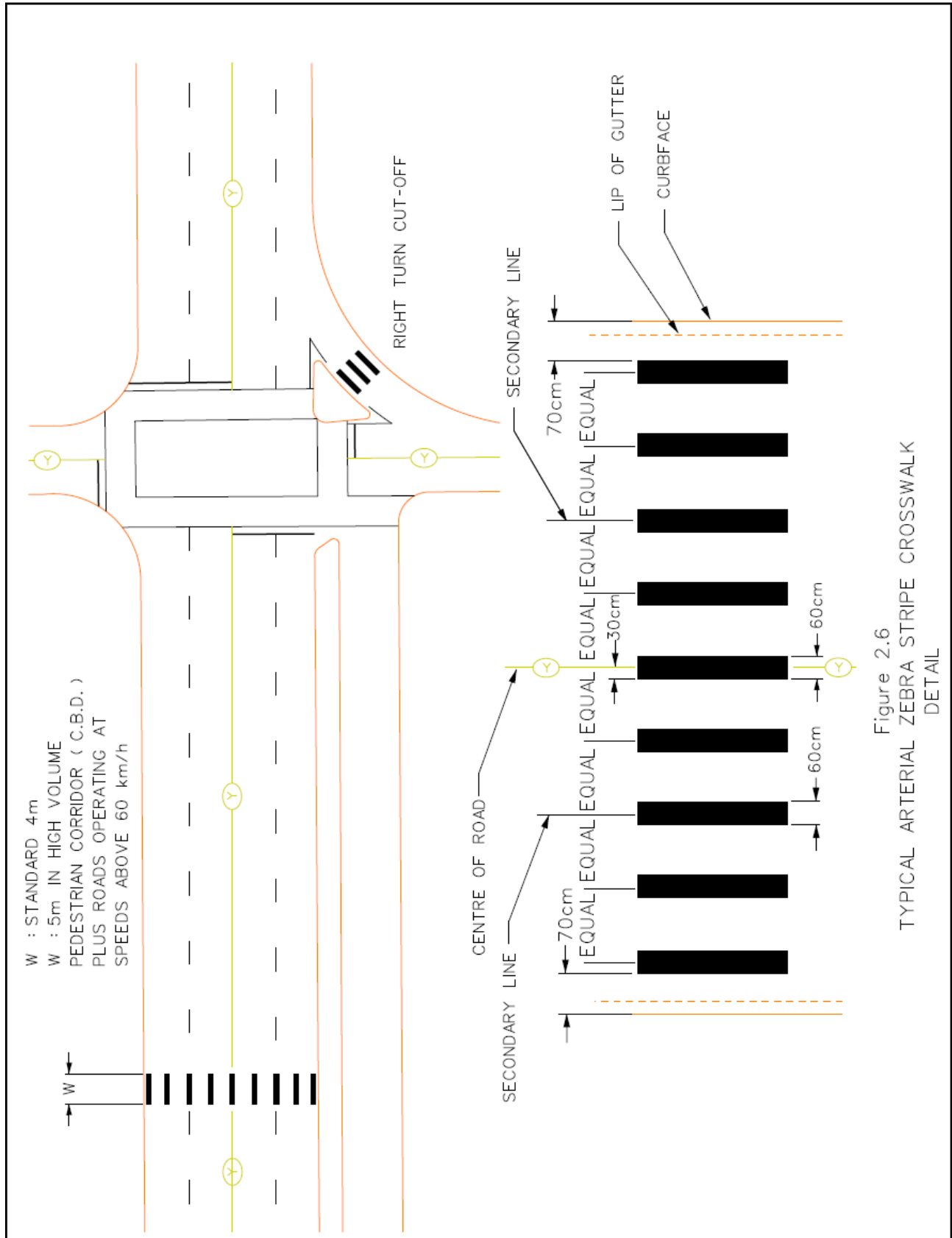


Figure 2.6
TYPICAL ARTERIAL ZEBRA STRIPE CROSSWALK
DETAIL

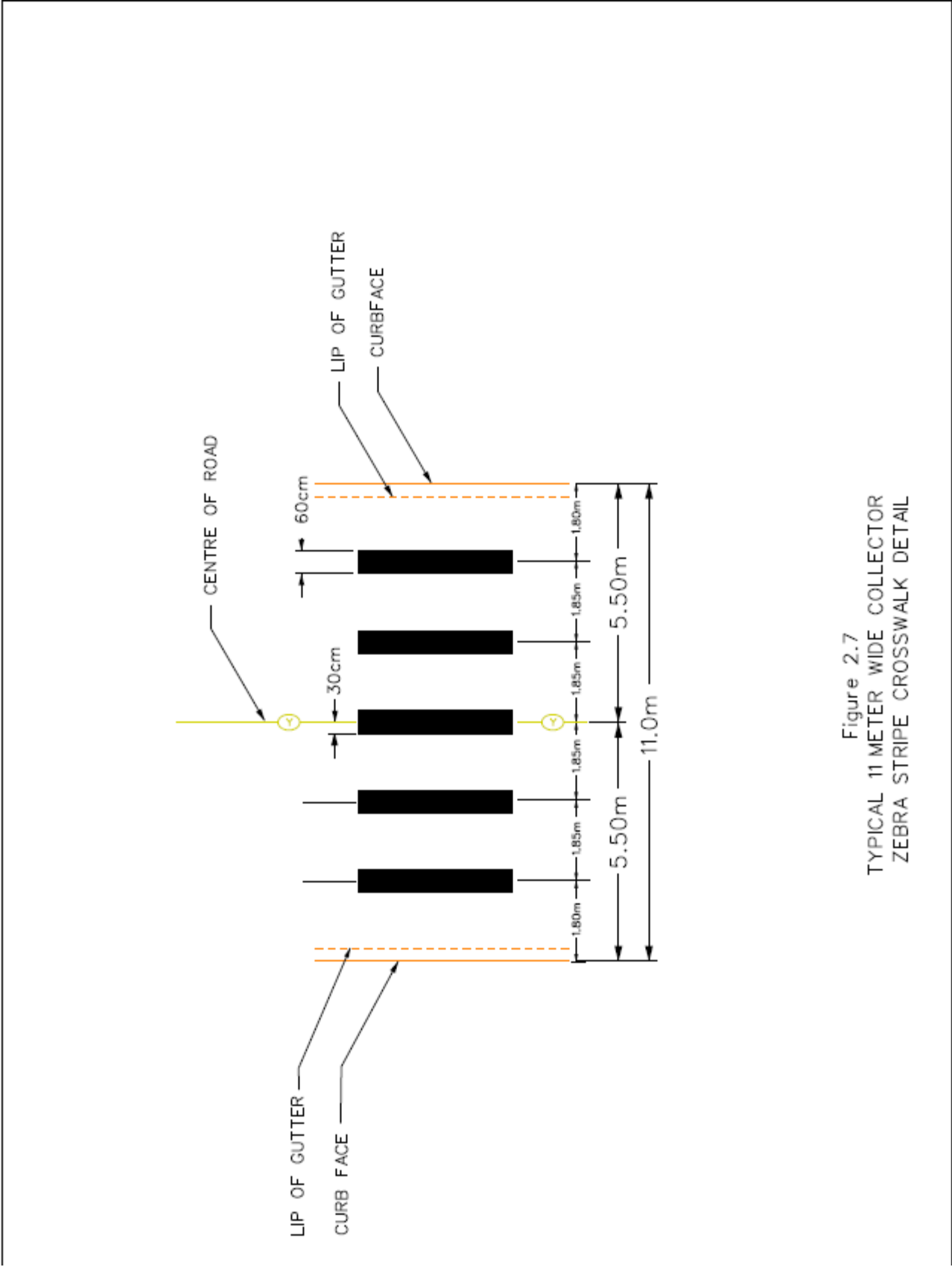


Figure 2.7
 TYPICAL 11 METER WIDE COLLECTOR
 ZEBRA STRIPE CROSSWALK DETAIL

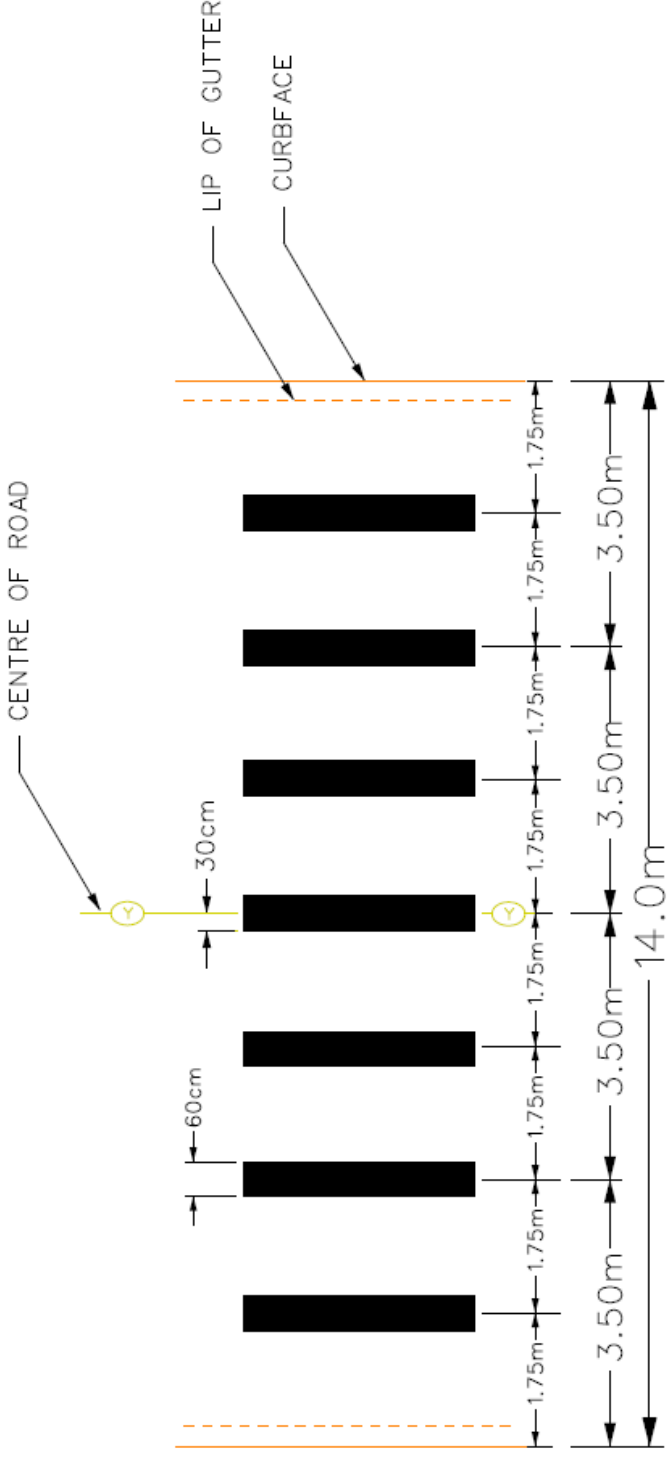
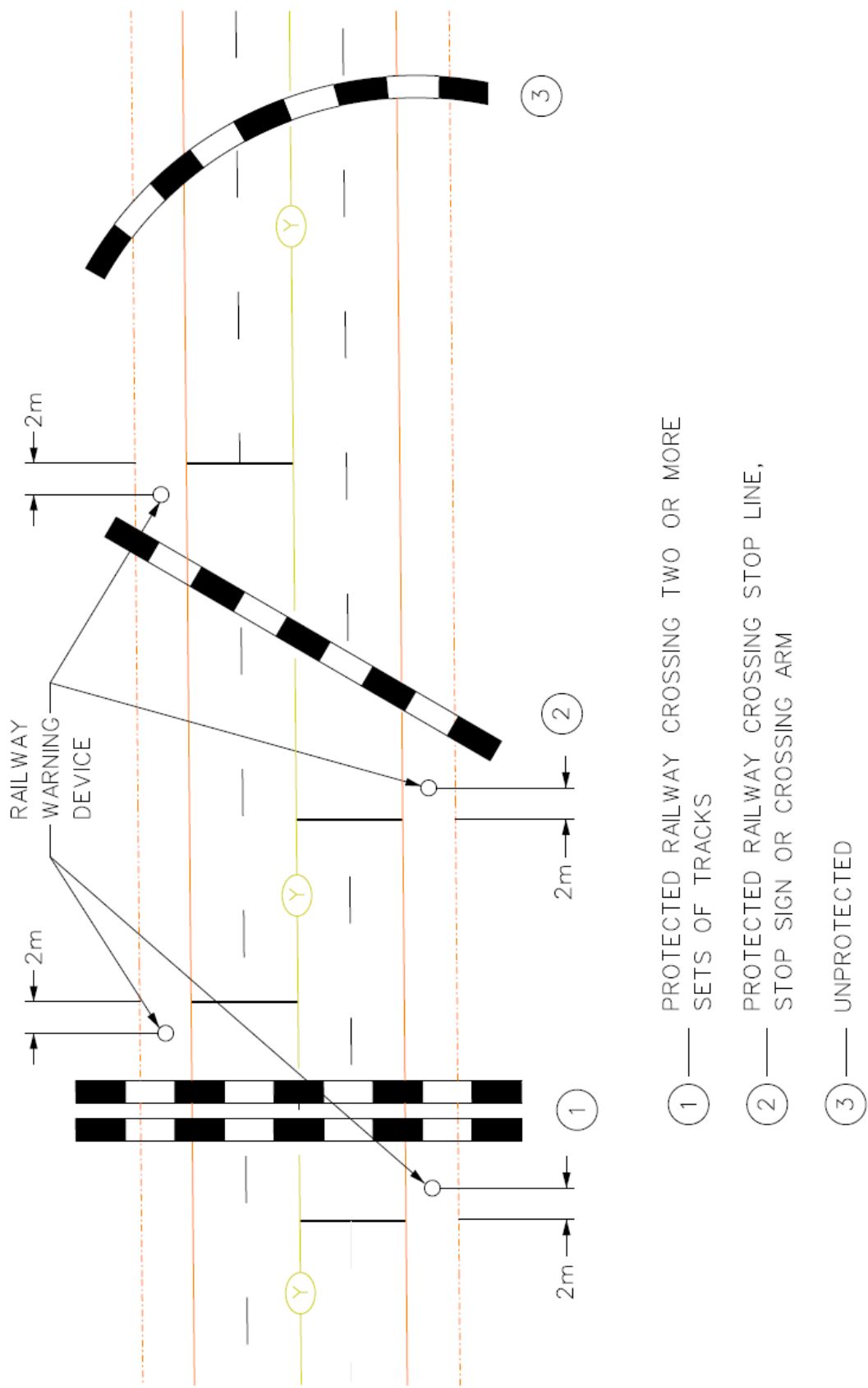


Figure 2.8
 TYPICAL 14 METER WIDE COLLECTOR
 ZEBRA STRIPE CROSSWALK DETAIL



- ① — PROTECTED RAILWAY CROSSING TWO OR MORE SETS OF TRACKS
- ② — PROTECTED RAILWAY CROSSING STOP LINE, STOP SIGN OR CROSSING ARM
- ③ — UNPROTECTED

Figure 2.14
 STOP LINES AT RAILWAY CROSSINGS

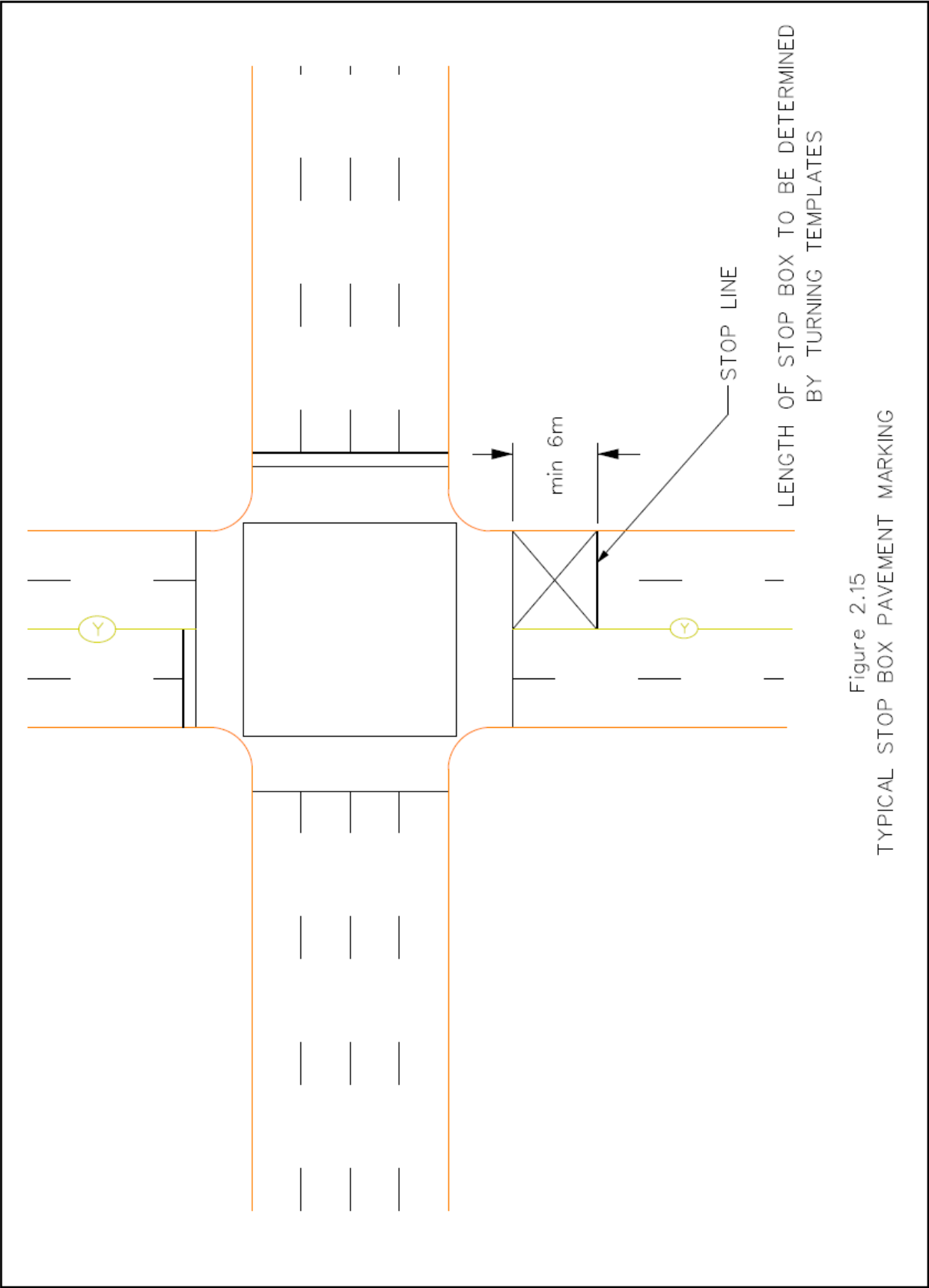


Figure 2.15
TYPICAL STOP BOX PAVEMENT MARKING

3.0 MERGING and DIVERGING AREAS

Pavement markings in merging and diverging zones are used to allow for smoother vehicular transitions between vehicles travelling at different or identical speeds. This includes:

- 3.1 Gore Areas
- 3.2 Continuity Lines
- 3.3 Multiple Lane Entry / Exit

3.1 GORE AREAS

Gore area markings are used to define the beginning and the end of merge and diverge zones and the approaches to structures in the roadway.

Gore area marking shall :

- be solid 10 cm wide centre line where traffic passes the gore area in opposing directions. (Figure 3.1).
- extend from a point 10 m past the point of the physical barrier to a point where the lane widths in opposing travel directions are a constant width. (Figure 3.1).
- be solid 20 cm wide lines where traffic passes by the gore area in the same direction on Freeways or roadways with a speed limit of 70 km/h or higher.
- be solid 10 cm wide lines where traffic passes by the gore area in the same direction on roadways with a speed limit of less than 70 km/h.
- be unmarked inside the gore area lines unless safety concerns warrant interior markings.
- extend from the point of the physical obstruction to a point where the lane width of the ramp and through lane reach 5.50 m and 3.70 m, respectively, when in the same direction of flow.

For left turn slab-on islands, the pavement markings shall be :

- 10 cm in width,
- white in color,
- marked as shown in Figure 3.6.

Edge lines shall be installed in merge and diverging zones:

- where a shoulder is provided, or
- where the gutter width is greater than 0.6 m.

Edge lines should be 10 cm in width and transition to 20 cm in width at a distance of 10 m before the beginning of taper in a diverge area, and at a distance of 10 m past the end of taper in a merge area.

See Figures 3.2 and 3.3.

“Emergency areas” shall be provided where the length of the merge / acceleration zone is not adequate to accommodate the merge maneuver.

Minimum Merge / Acceleration Zone Lengths

Roadway Speed Limit (km/h)	Minimum Acceleration Lane Length, La (m)
60	60
70	70
80	100
90	125
100	165
110	200

See Figure 3.4.

3.2 CONTINUITY LINES

Continuity lines indicate the continuation of the through-travel lane from dedicated turning lanes and from merging / diverging lanes:

Continuity lines shall:

- be 20 cm in width,
- have a line to gap ratio of 3 m : 6 m,
- be used at all acceleration and deceleration lanes (shown in Figures 3.1 to 3.4) ,
- be used to separate auxiliary turn lanes from through lanes at intersections (Figure 3.5).

Continuity lines are not required for right-turn cut-offs without auxiliary turn lanes.

3.3 MULTIPLE LANE ENTRY / EXIT

3.3.1 ENTRY

Multiple lanes must merge into one single lane before merging onto the highway.

Continuity lines shall be used for indicating the transition / merge zones for the merging lanes. These lines shall be :

- 20 cm in width,
- 3 m : 6 m line gap ratio.

See Figure 3.7 for an example.

3.3.2 EXIT

3.3.2.1

Where two lanes exit a highway, the pavement marking lines shall be marked as shown in Figures 3.7 to 3.9.

3.3.2.2

At exits where one of the lanes is an optional straight-through or turn lane, the exit shall be marked as shown in Figures 3.10 and 3.11.

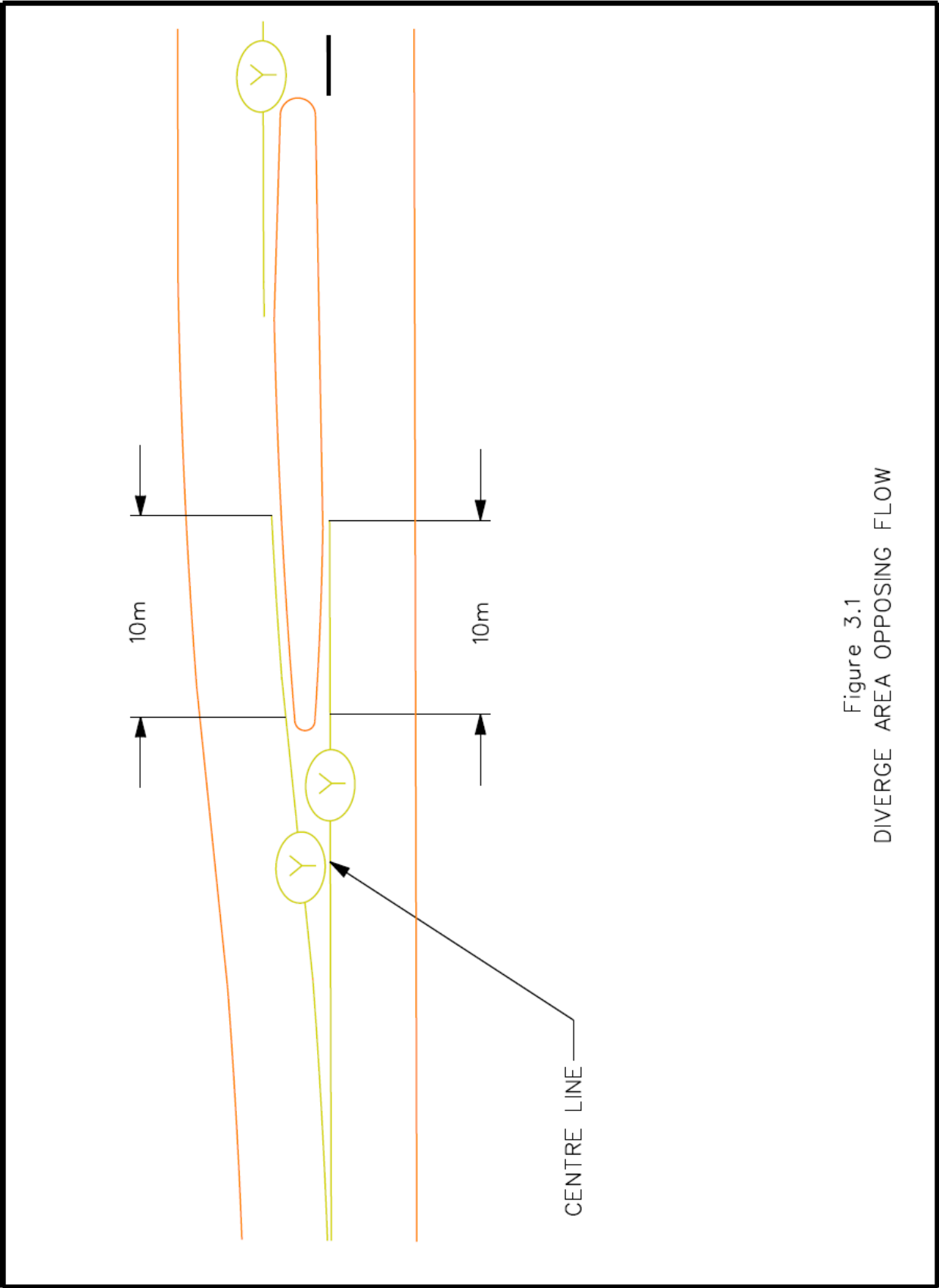


Figure 3.1
DIVERGE AREA OPPOSING FLOW

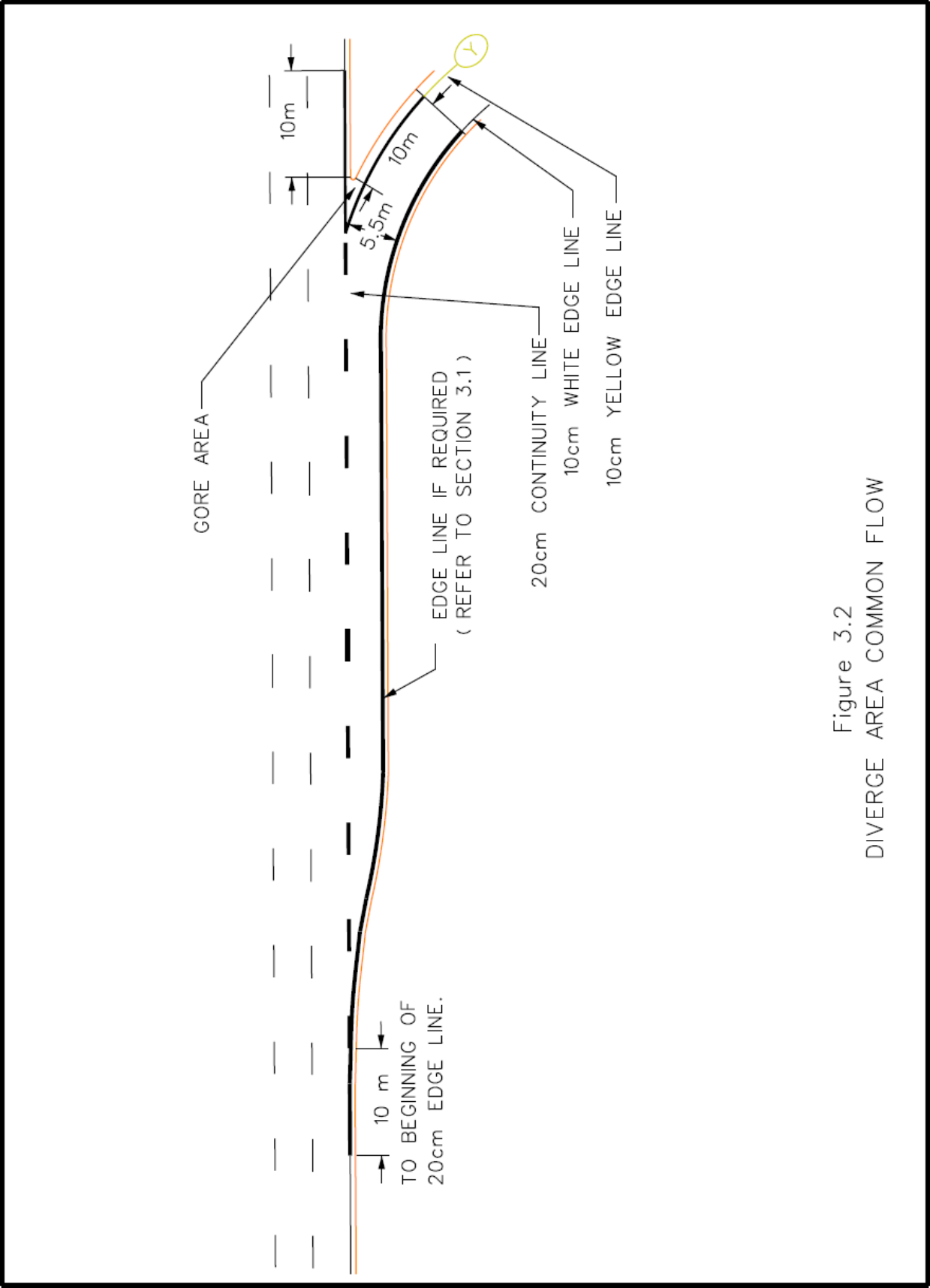


Figure 3.2
DIVERGE AREA COMMON FLOW

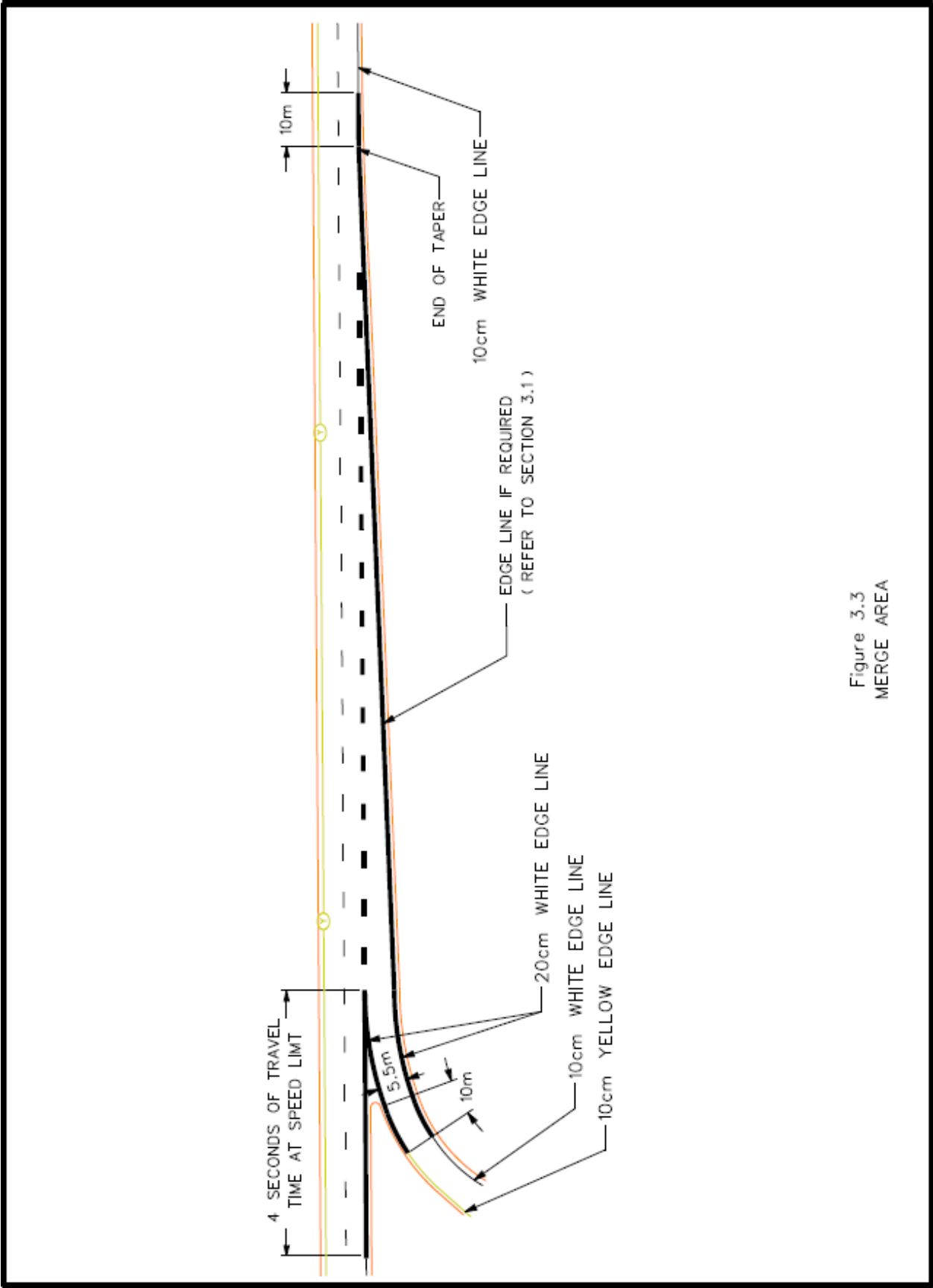


Figure 3.3
 MERGE AREA

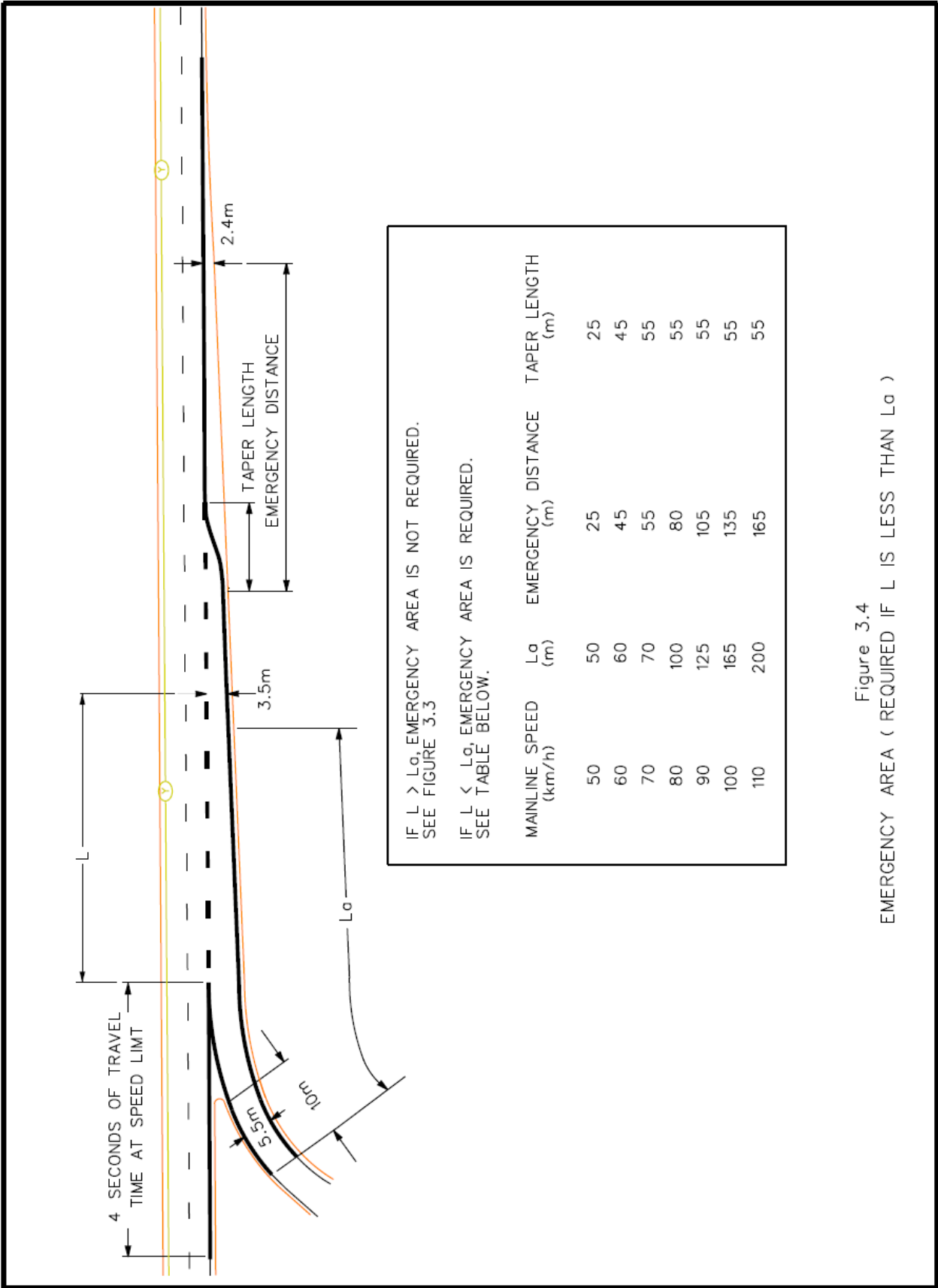


Figure 3.4
 EMERGENCY AREA (REQUIRED IF L IS LESS THAN L_a)

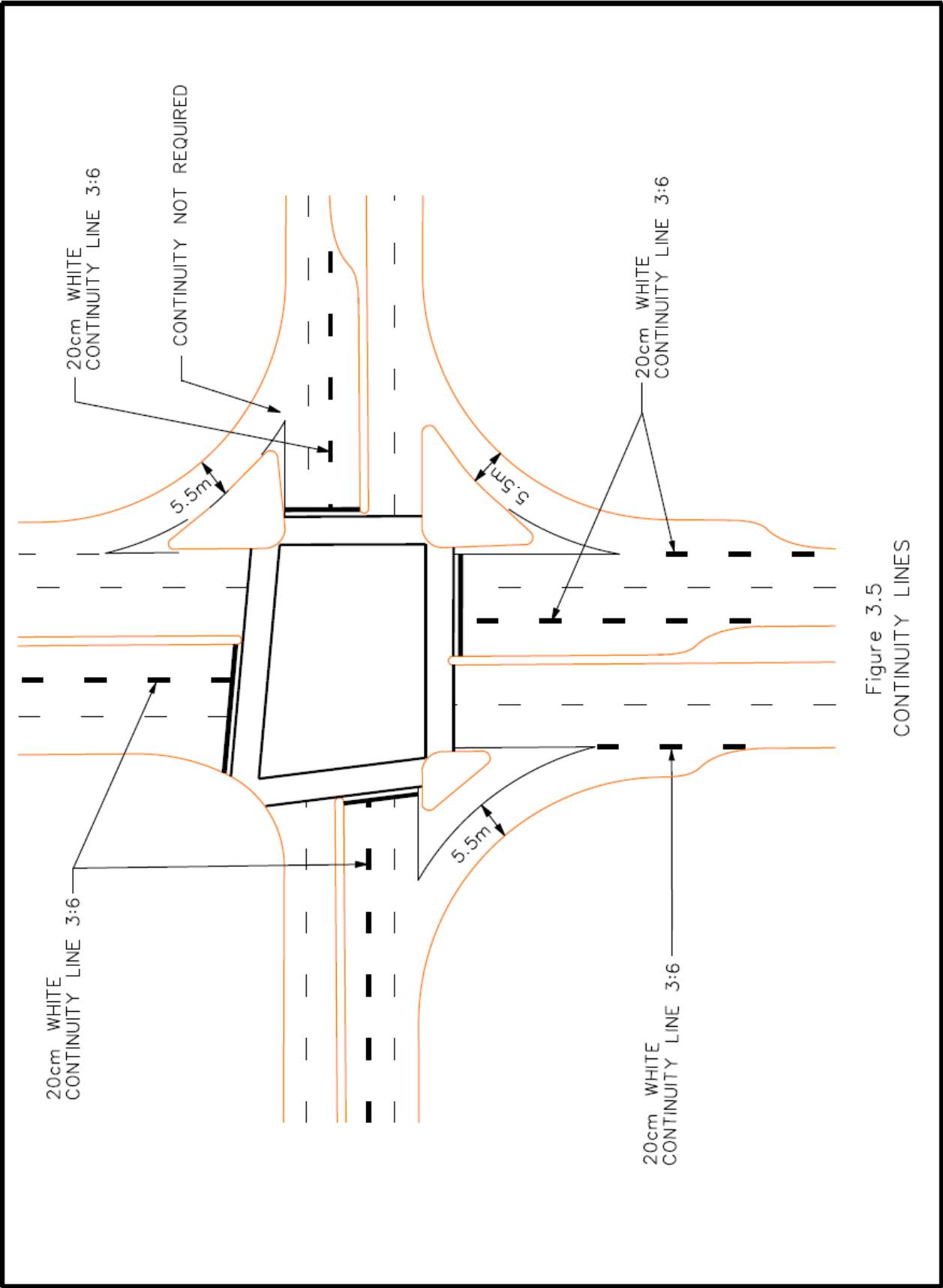


Figure 3.5
CONTINUITY LINES

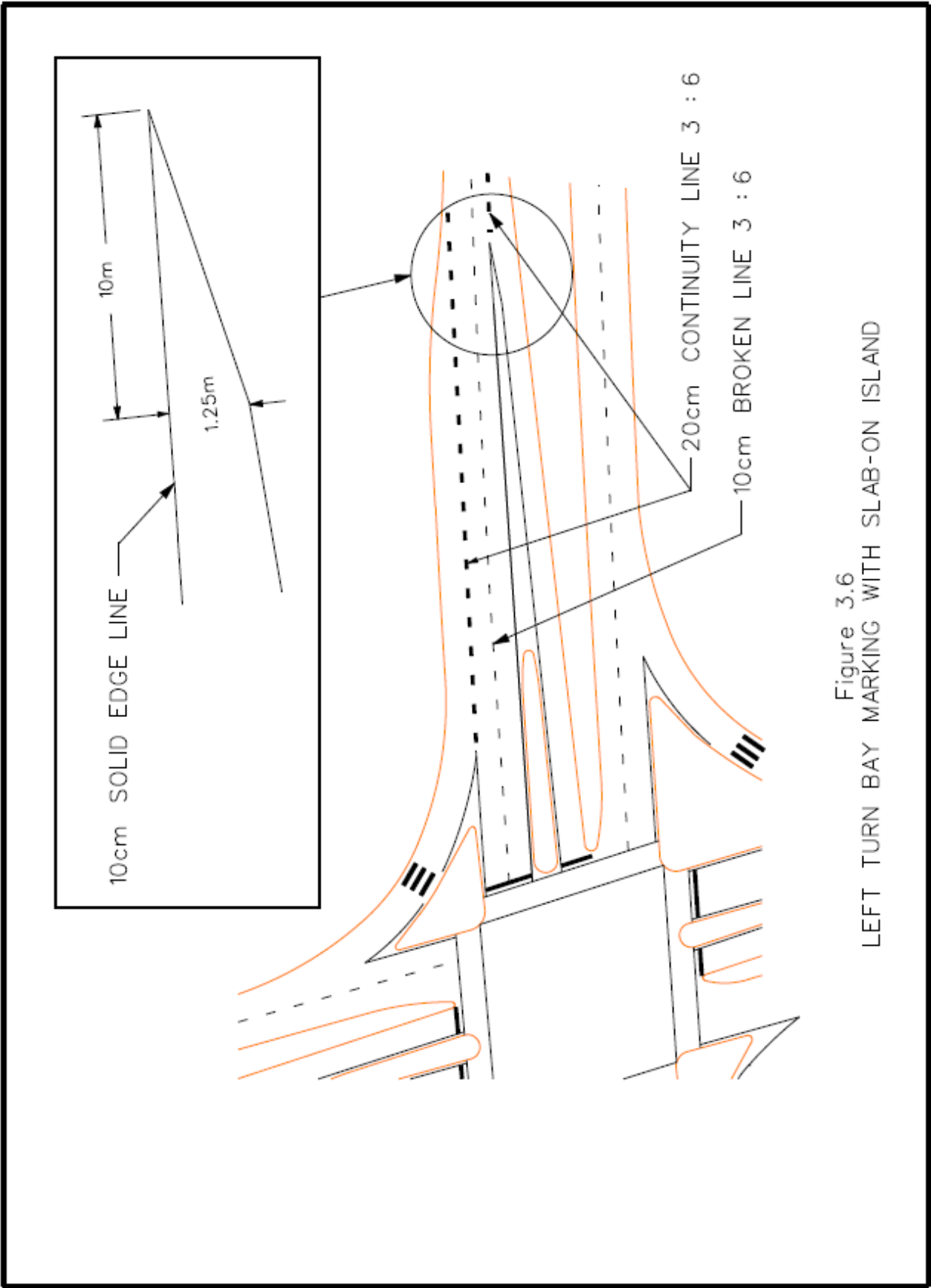


Figure 3.6
LEFT TURN BAY MARKING WITH SLAB-ON ISLAND

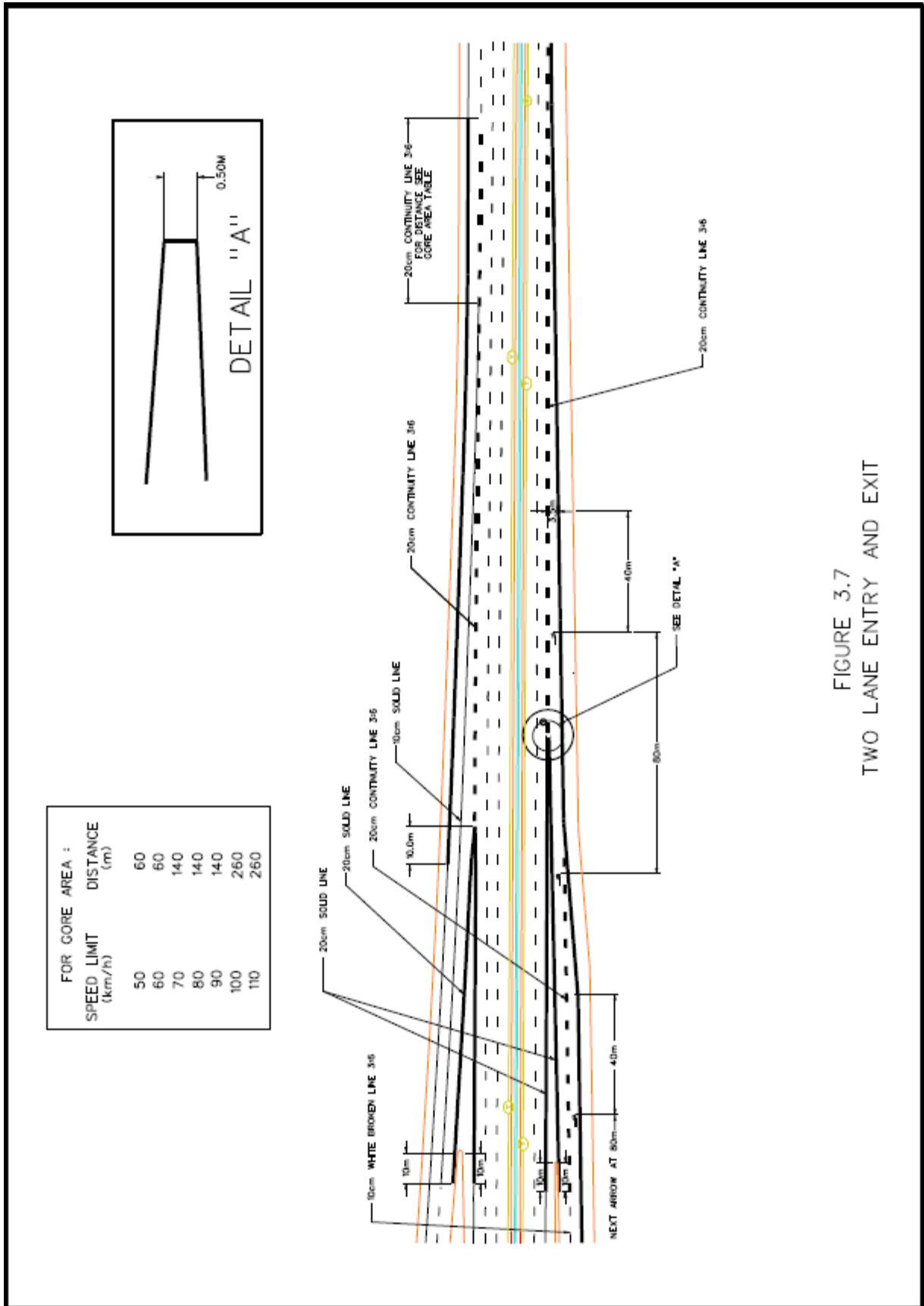
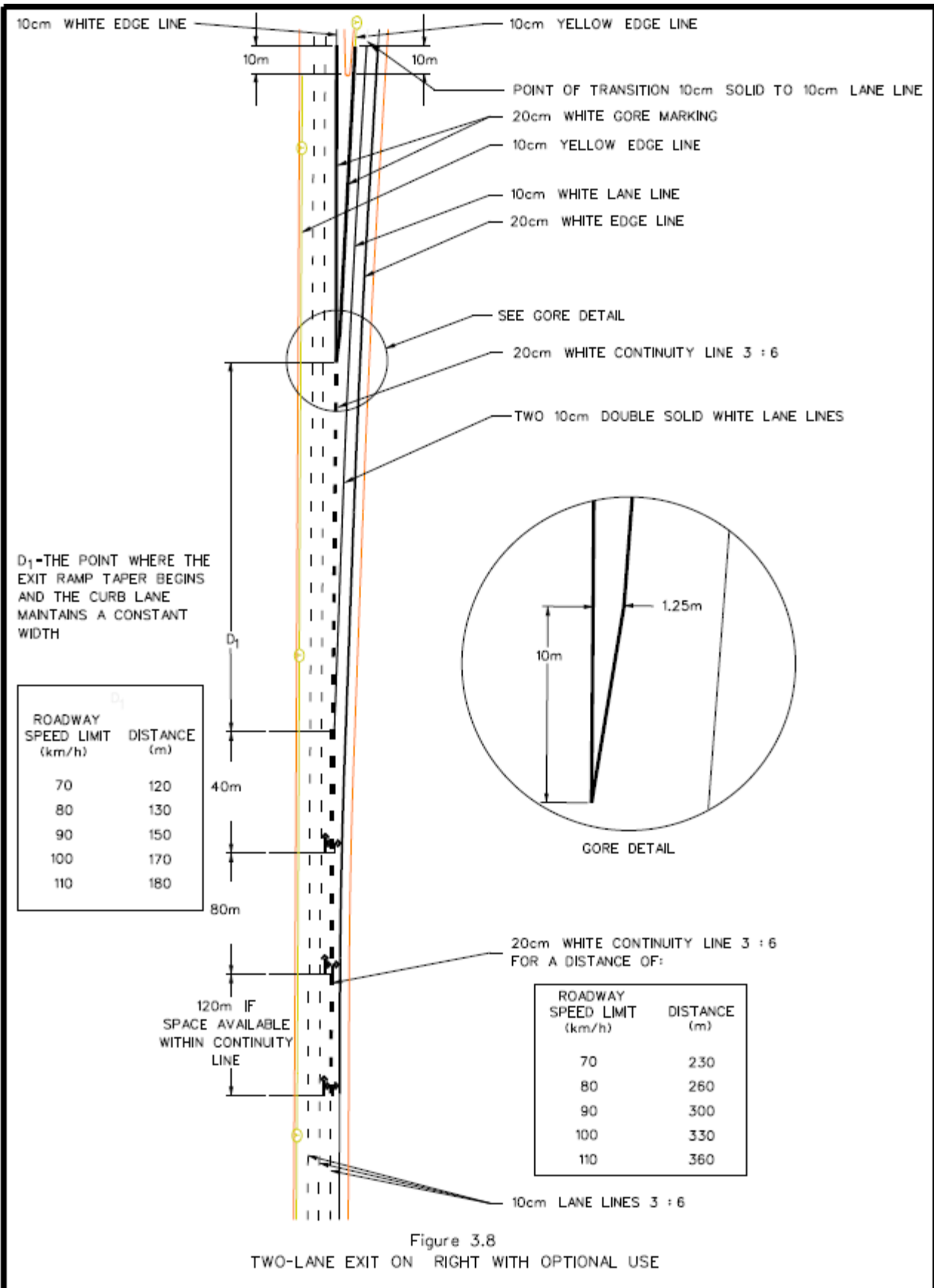


FIGURE 3.7
 TWO LANE ENTRY AND EXIT



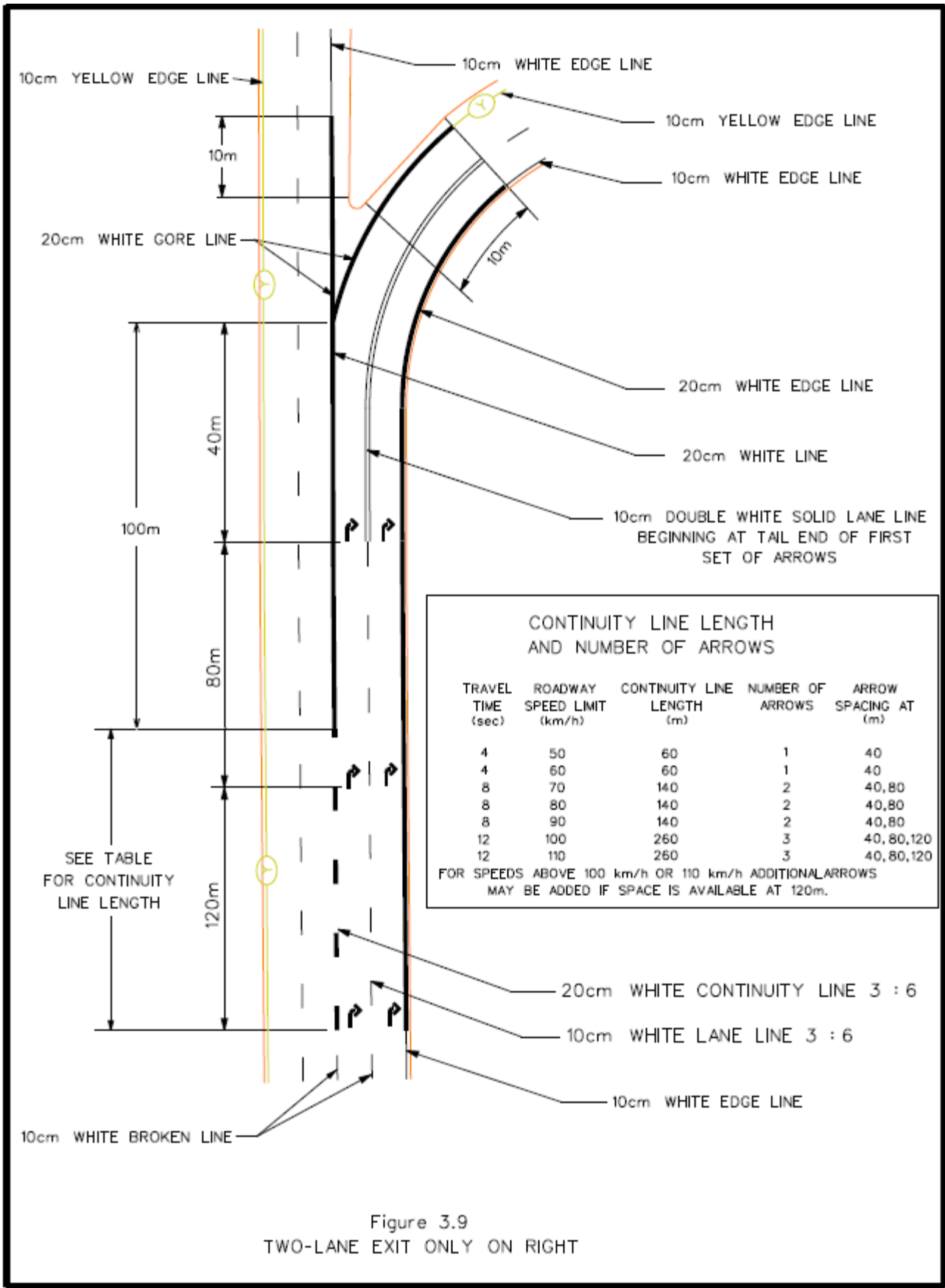
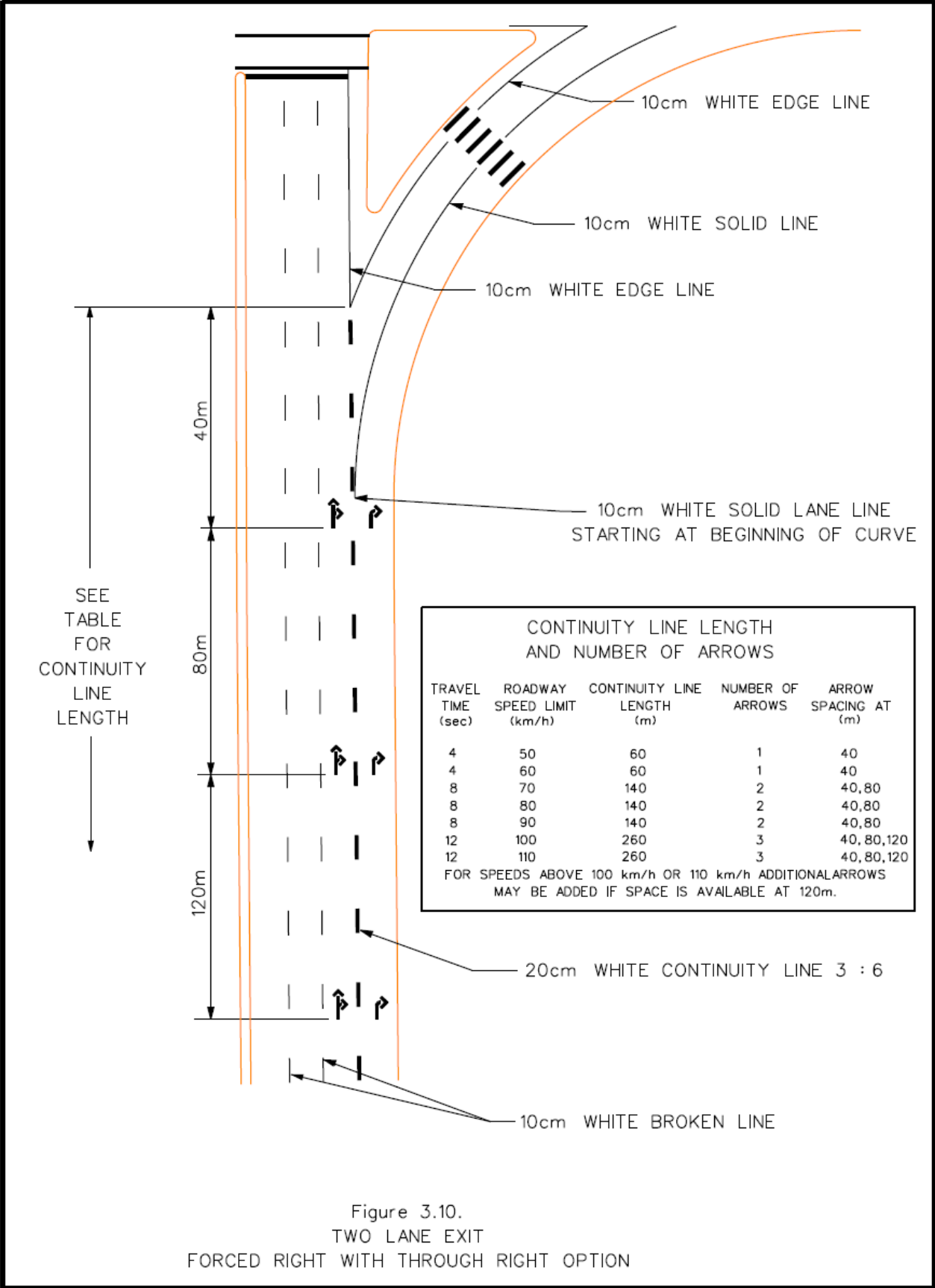


Figure 3.9
 TWO-LANE EXIT ONLY ON RIGHT



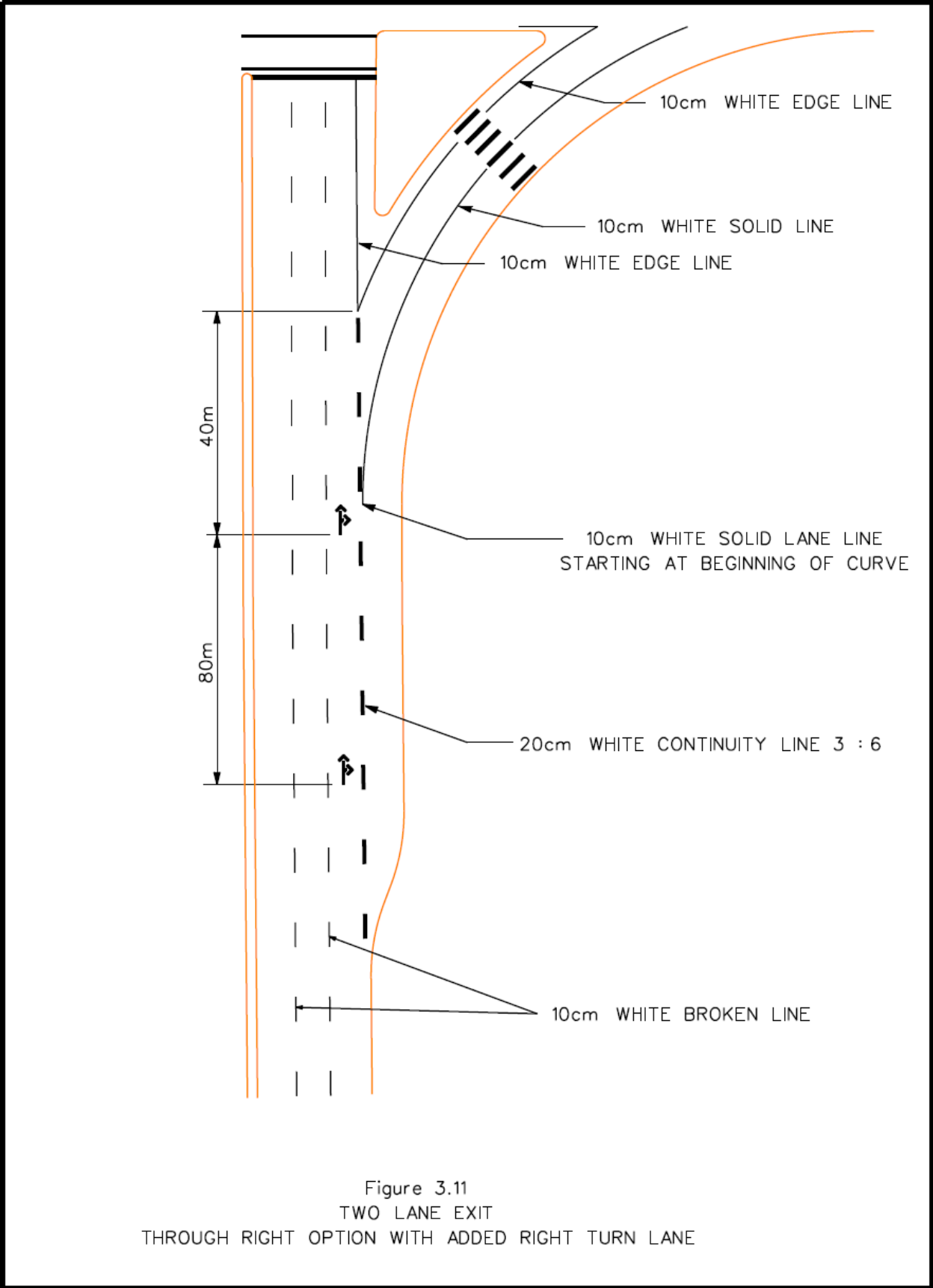
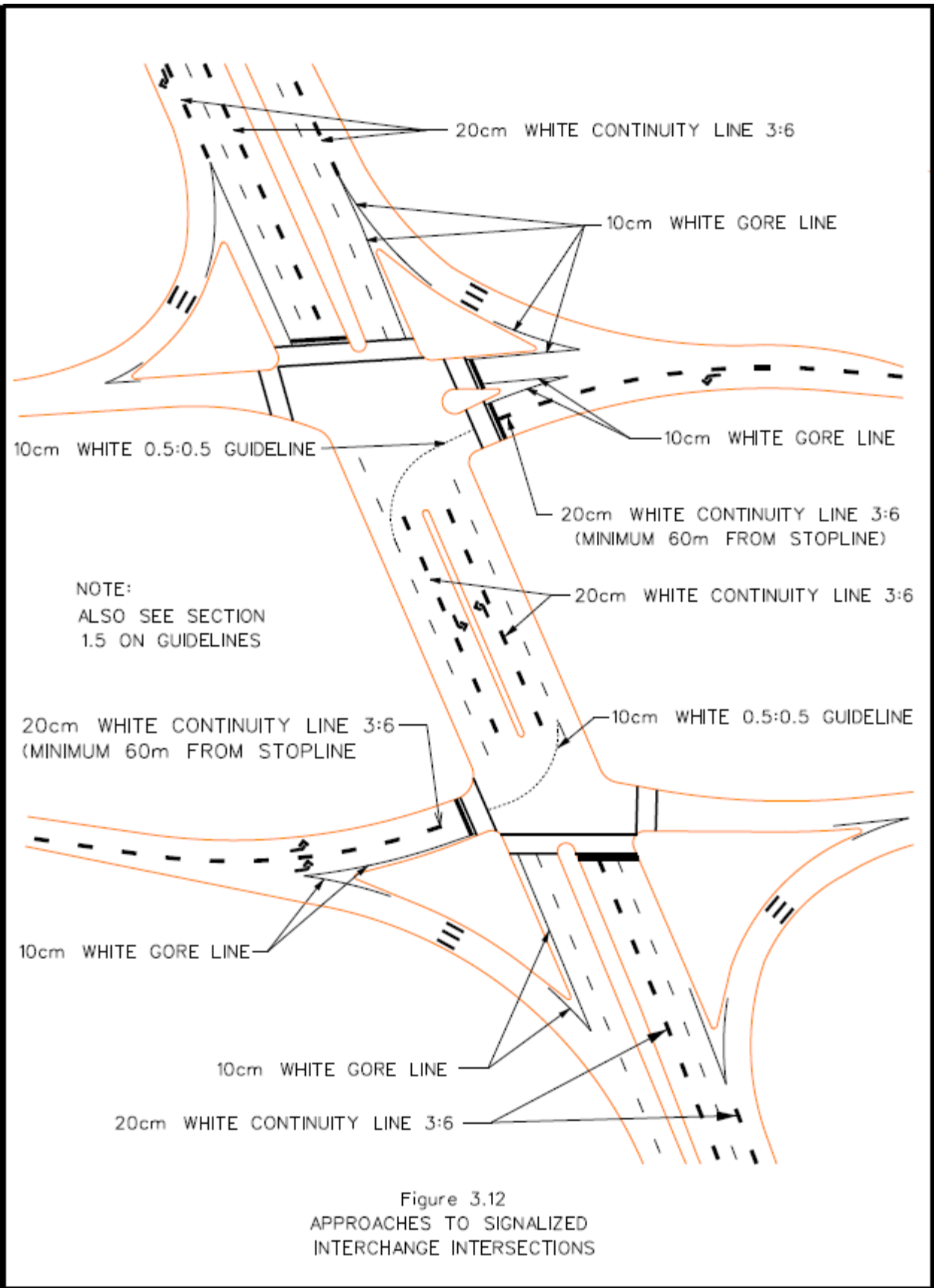


Figure 3.11
 TWO LANE EXIT
 THROUGH RIGHT OPTION WITH ADDED RIGHT TURN LANE



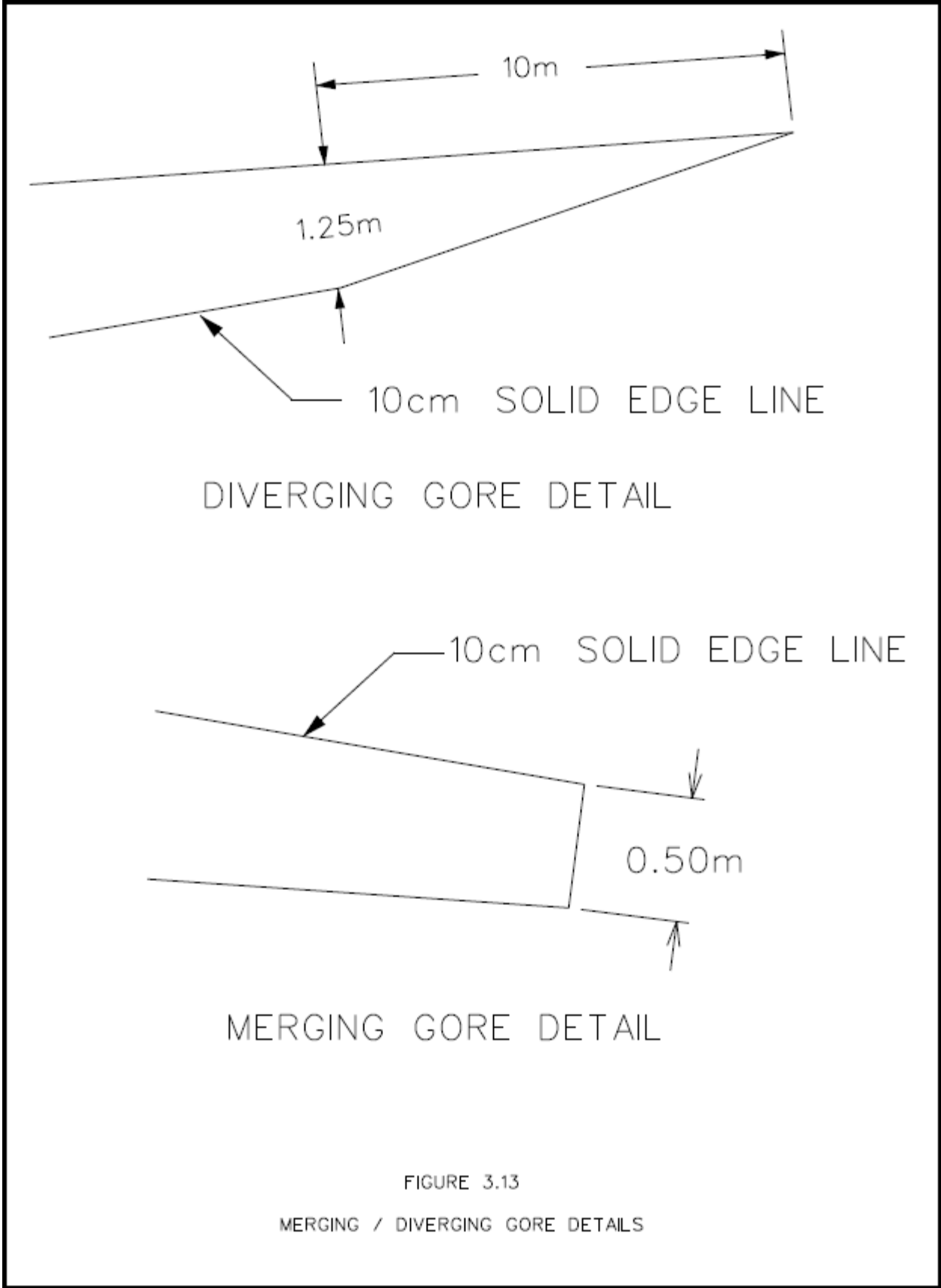


FIGURE 3.13

MERGING / DIVERGING GORE DETAILS

4.0 SYMBOLS AND LETTERS

Pavement marking symbols and letters shall:

- be defined as a symbol or series of numbers or letters painted onto the roadway surface.
- serve to inform the motorist of some form of traffic control ahead.
- be provided in each applicable travel lane in the direction of travel.
- be white.

The dimensions of pavement marking letters and numbers used are from Section C1.5.4, figures C1-7 to C1-9, table C1-1 of the 2021 Manual on Uniform Traffic Control Devices of Canada (MUTCDC).

From Section C1.5.4 of the 2021 MUTCDC:

“The following principles apply to symbols and words:

- All symbols and words are white.
- The use of symbols is preferred to words.
- Where used, word messages should be as brief as possible.
- Because of the low angle at which such markings are viewed, they must be elongated in the direction of traffic movement to provide adequate legibility.”

The relevant symbol details are shown in Figures 4.4 to 4.13.

4.1 ARROWS

Arrows indicate to the motorist the required through or turn movement that they are to perform from the lane they are traveling in. Arrows must be used in conjunction with either a ground or overhead mounted signing.

Examples of arrow placement are shown in Figures 4.1 to 4.3.

Full size arrows are shown in Figures 4.4 to 4.6.

4.1.1 THROUGH ARROWS

Through-traffic only arrows are uncommon and are only used at intersections where any or one intersection leg has more than four approaches and where the movements in specific lanes are not well indicated.

4.1.2 LEFT OR RIGHT TURN ARROWS

Left or right turn arrows are required for the following two conditions:

- 1) At intersections where a lane that was through-only before the intersection is required to make a forced left or right turn.
- 2) At “unprotected” left turn lanes; i.e. where no curb is present between the left-turn lane and the traffic traveling in the opposing direction.

See Figures 4.2, 4.3.

4.1.3 THROUGH-LEFT OR THROUGH-RIGHT OPTION ARROWS

This type of arrow is required only when placed in the lane parallel to a forced left/right turn lane.

4.1.4 MERGE ARROWS

Merge arrows are used when a merge lane is greater than 200m, when there is a left or right lane drop, or on a double lane entry.

See Figures 3.7 and 4.1.

4.2 BICYCLE SYMBOL

Bicycle lanes are identified by a white elongated bicycle pavement marking. This symbol is 1.0 m wide, with an elongated length of 2.0 m.

See Figure 4.8.

When applied on a bike route, symbol markings should be placed in advance of, and following each intersection. In instances where intersections are more than 400 m apart, bicycle symbols may be placed every 200 m in order to remind drivers that the facility is designed to accommodate bicycles. Symbol markings may also be placed more frequently, as needed, in order to highlight the possible presence of bicycles.

A non-elongated bicycle symbol pavement marking is used:

- in conflict zones, and
- in bike boxes

See Figure 4.7

4.3 SHARED USE LANE SYMBOL (SHARROW)

Shared use lane markings, or “sharrows” are symbols placed on the pavement surface in the intended area of bicycle travel. The symbols raise awareness to both cyclists and motorists of the correct cyclist positioning in the lane. Two white chevron markings, with a stroke width of 100 mm spaced at 100 mm are placed ahead of an elongated bicycle symbol.

See Figure 4.9

In shared lane applications, place immediately after an intersection and 10 m before the end of the block. Space longitudinally at intervals of 75 m (this spacing may be decreased but should not be increased, thus allowing drivers and cyclists to identify at all times where they should be situated in relation to one another).

4.4 RESERVED BICYCLE LANE DIAMOND

Reserved lanes are identified by a white elongated diamond symbol pavement marking. For reserved bicycle lanes, the stroke width of the diamond symbol is a minimum of 75 mm. The diamond symbol is used with accompanying signing for reserved lanes.

See Figure 4.10

The diamond symbol is centered in the bicycle lane approximately 10 m downstream from each intersection or from each crosswalk. Additional diamond symbols may be used, depending on the distance between the intersection or the presence of major access points.

On with-flow reserved lanes, additional diamond symbols may be used if right turns are not permitted from the reserved lane.

4.5 BICYCLE LANE ARROW

The use of a directional arrow on a reserved bicycle lane may be used to designate the direction of travel where this may not be clear. Where motorists are not required to see the markings, reduced-size cyclist directional arrows may be used.

See Figures 4.11, 4.12 and 4.13.

Where a motorist must see and interpret the cyclist directional arrow, a full-sized elongated motorist directional arrow is used.

See Figures 4.4 to 4.6.

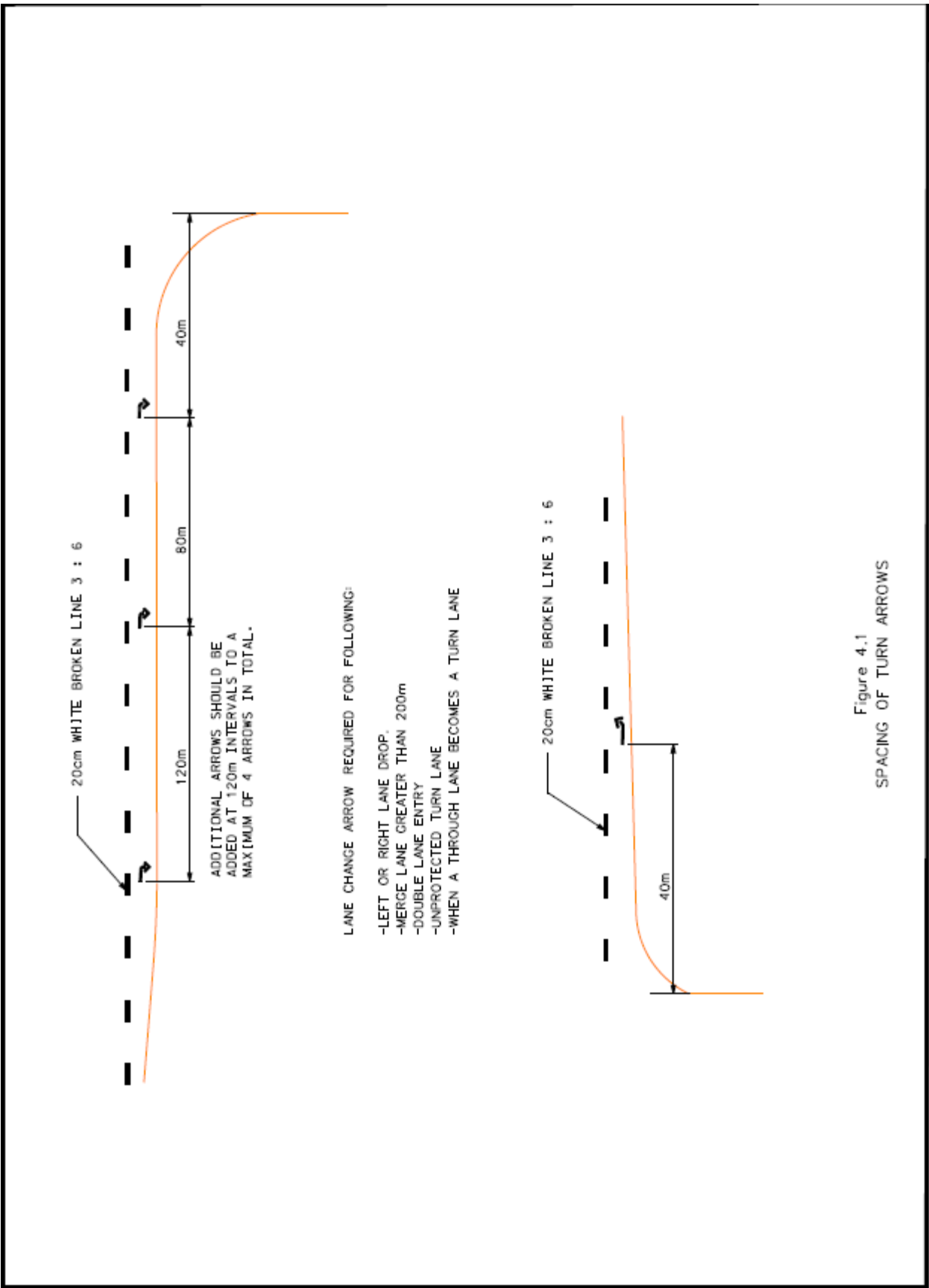
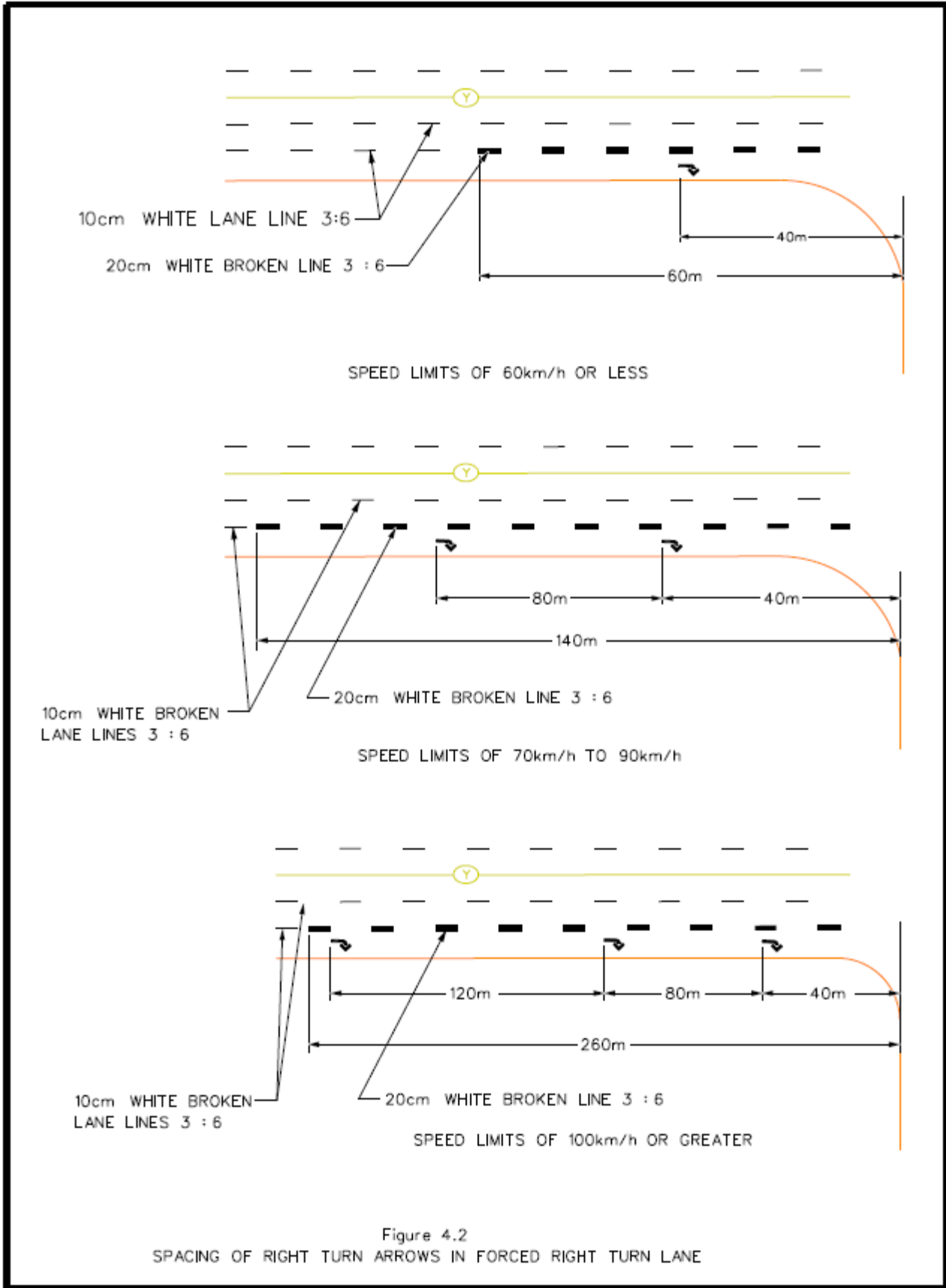
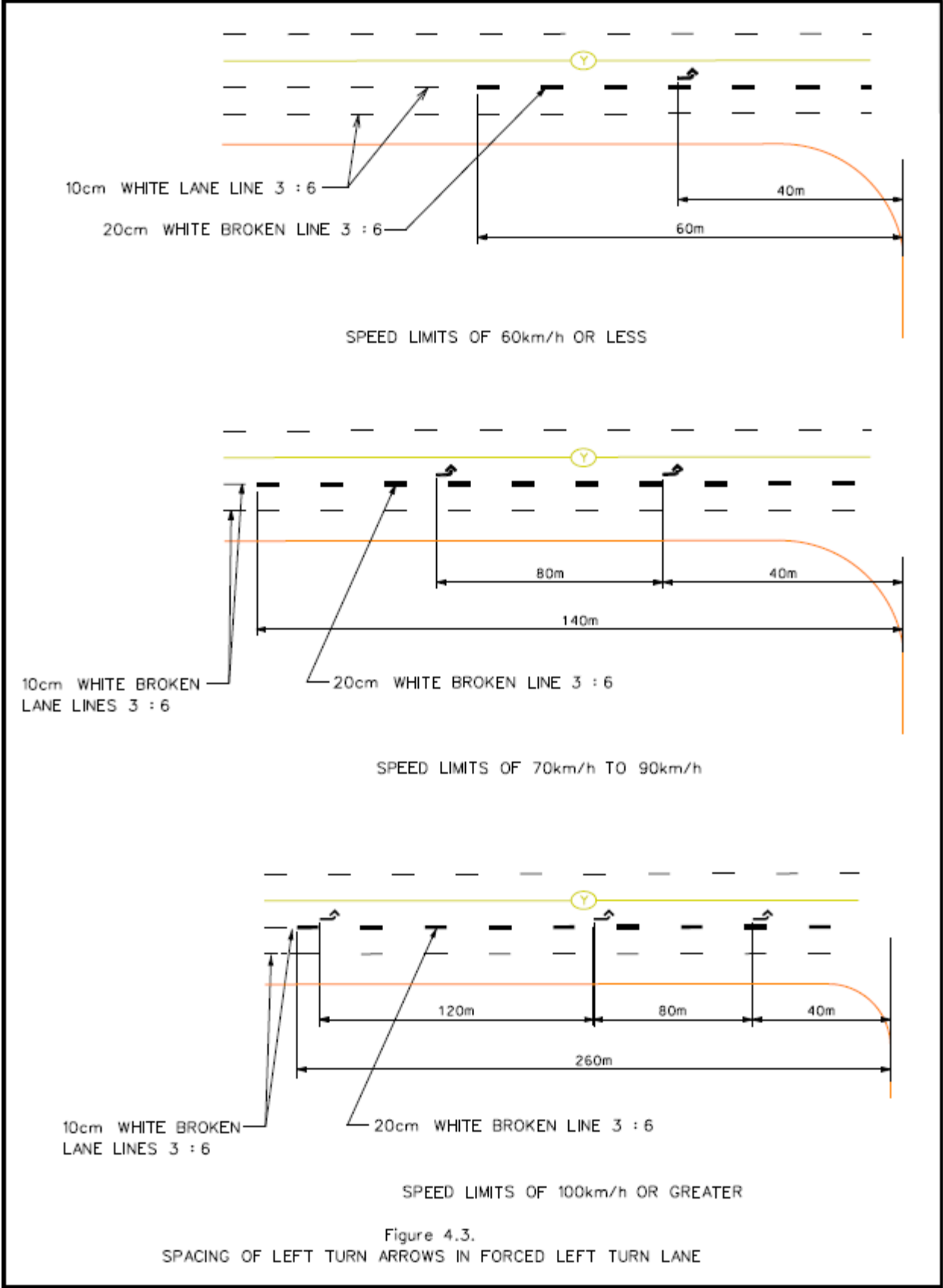


Figure 4.1
 SPACING OF TURN ARROWS





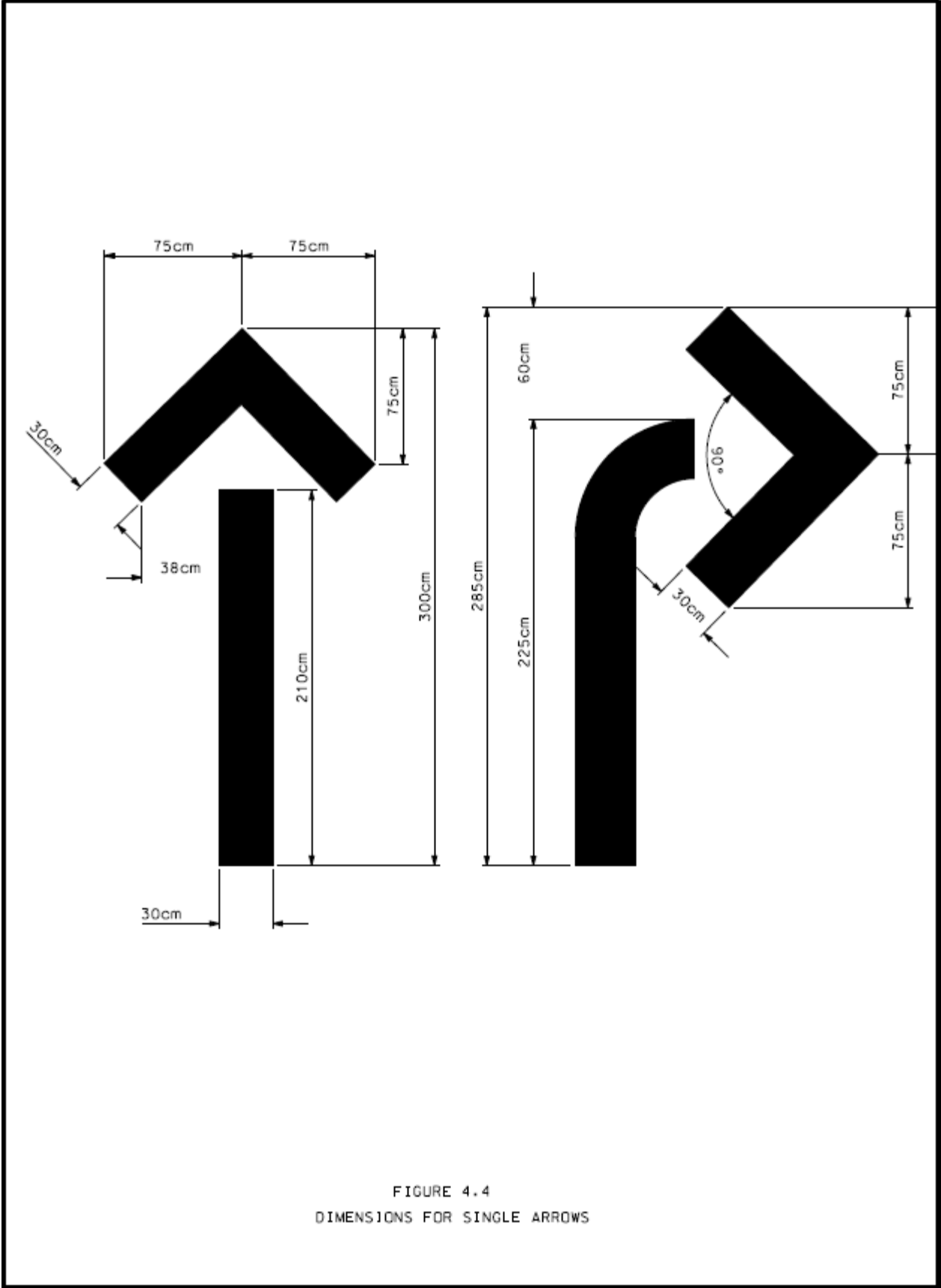


FIGURE 4.4
DIMENSIONS FOR SINGLE ARROWS

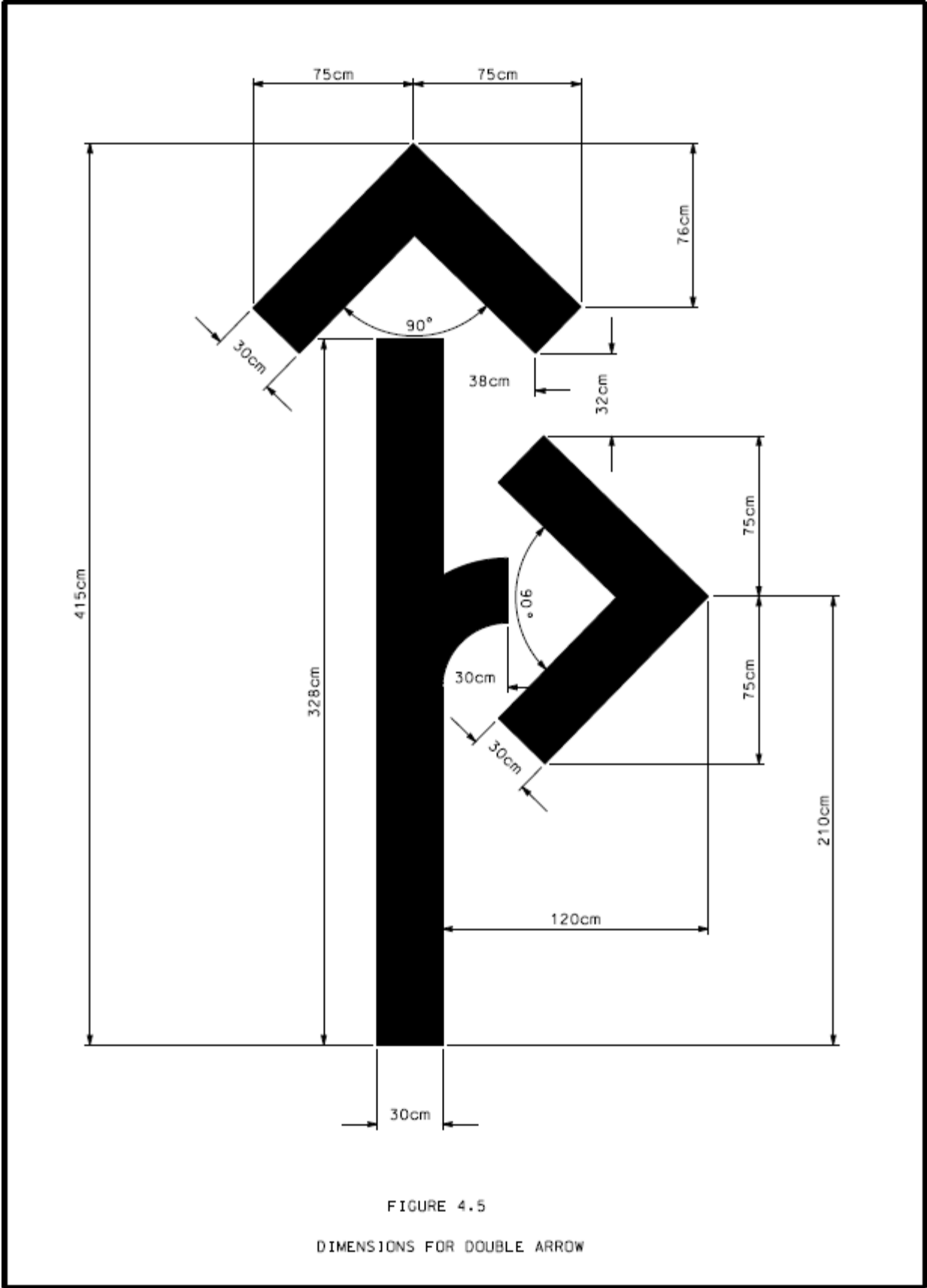


FIGURE 4.5

DIMENSIONS FOR DOUBLE ARROW

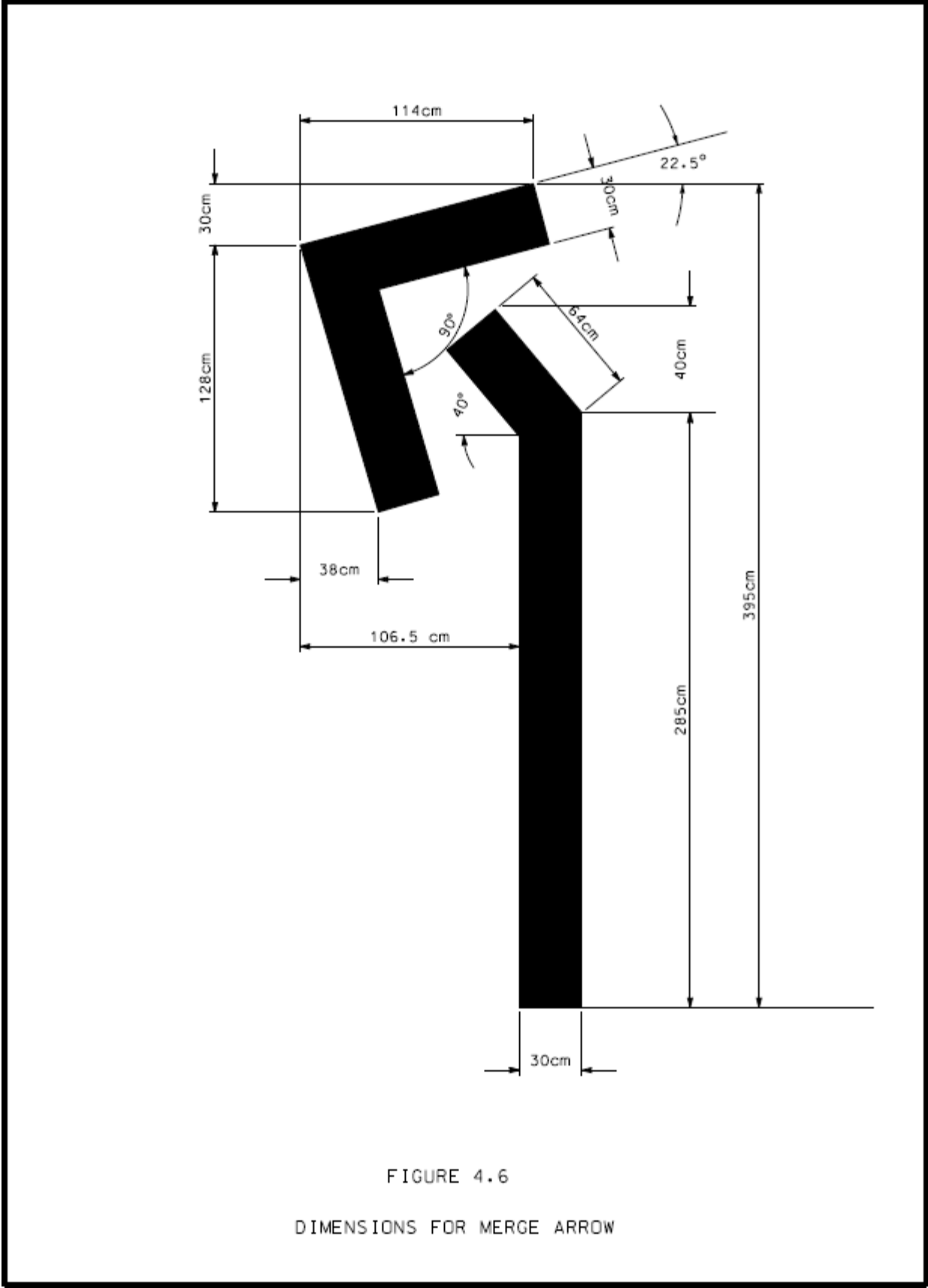
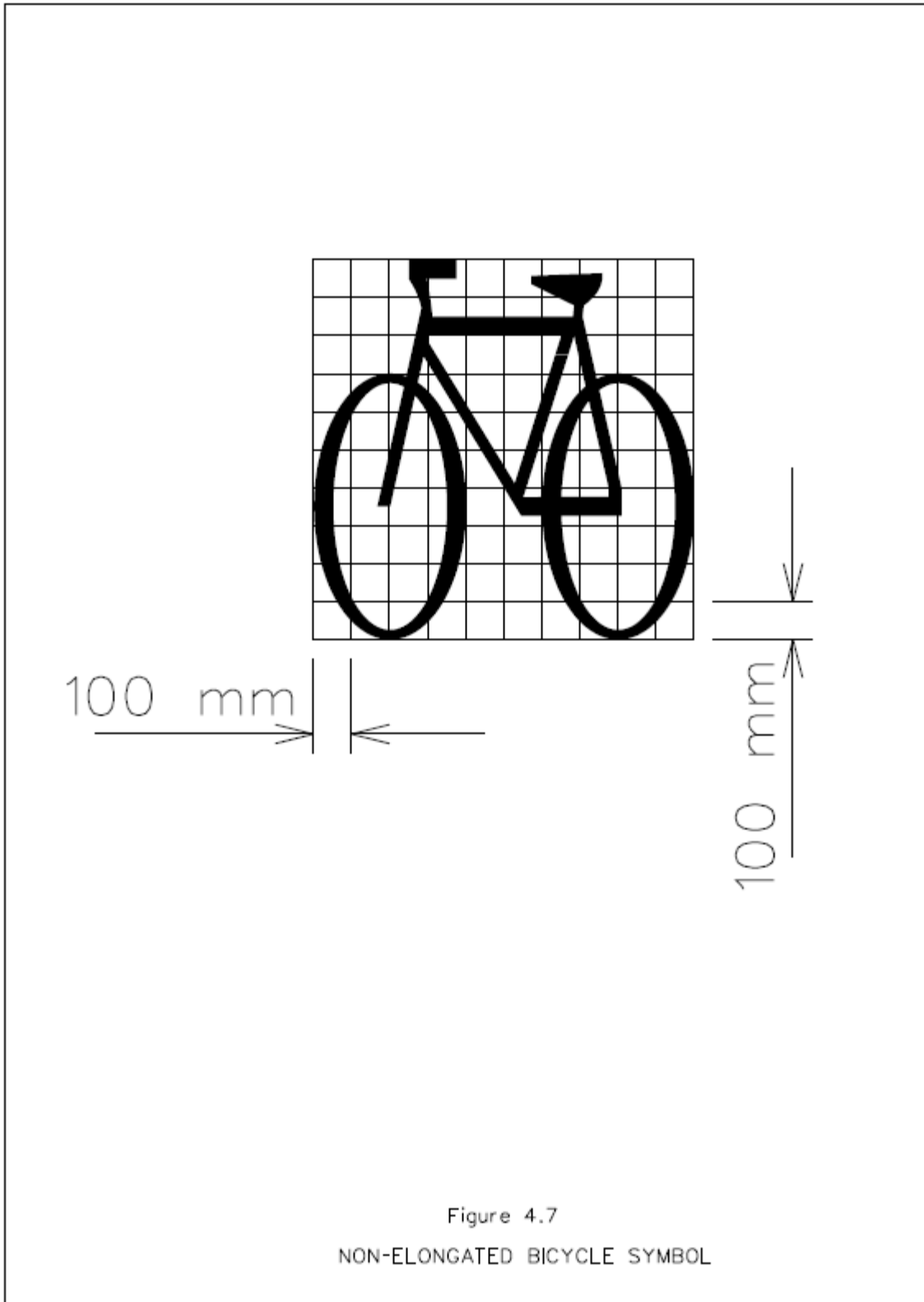
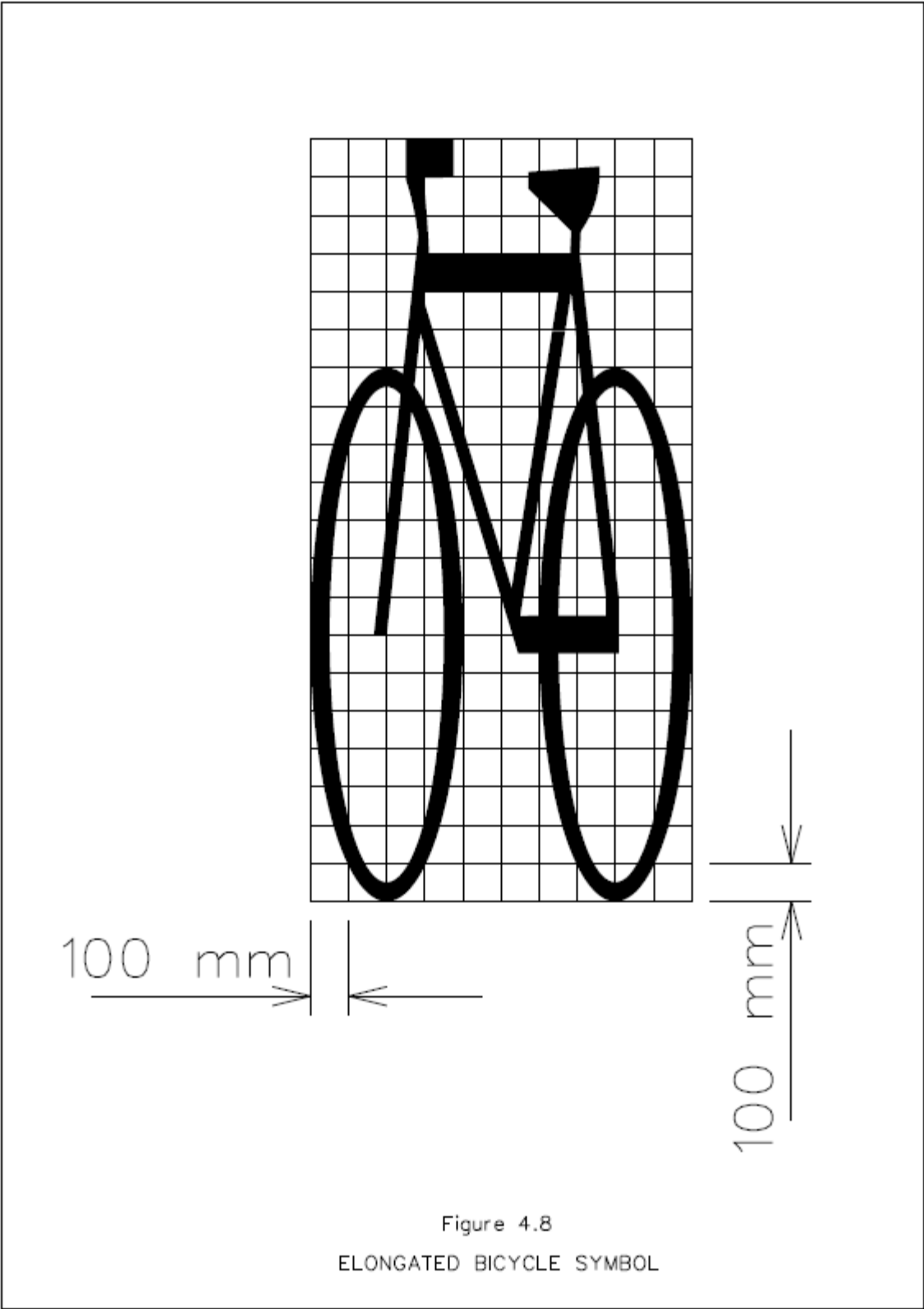
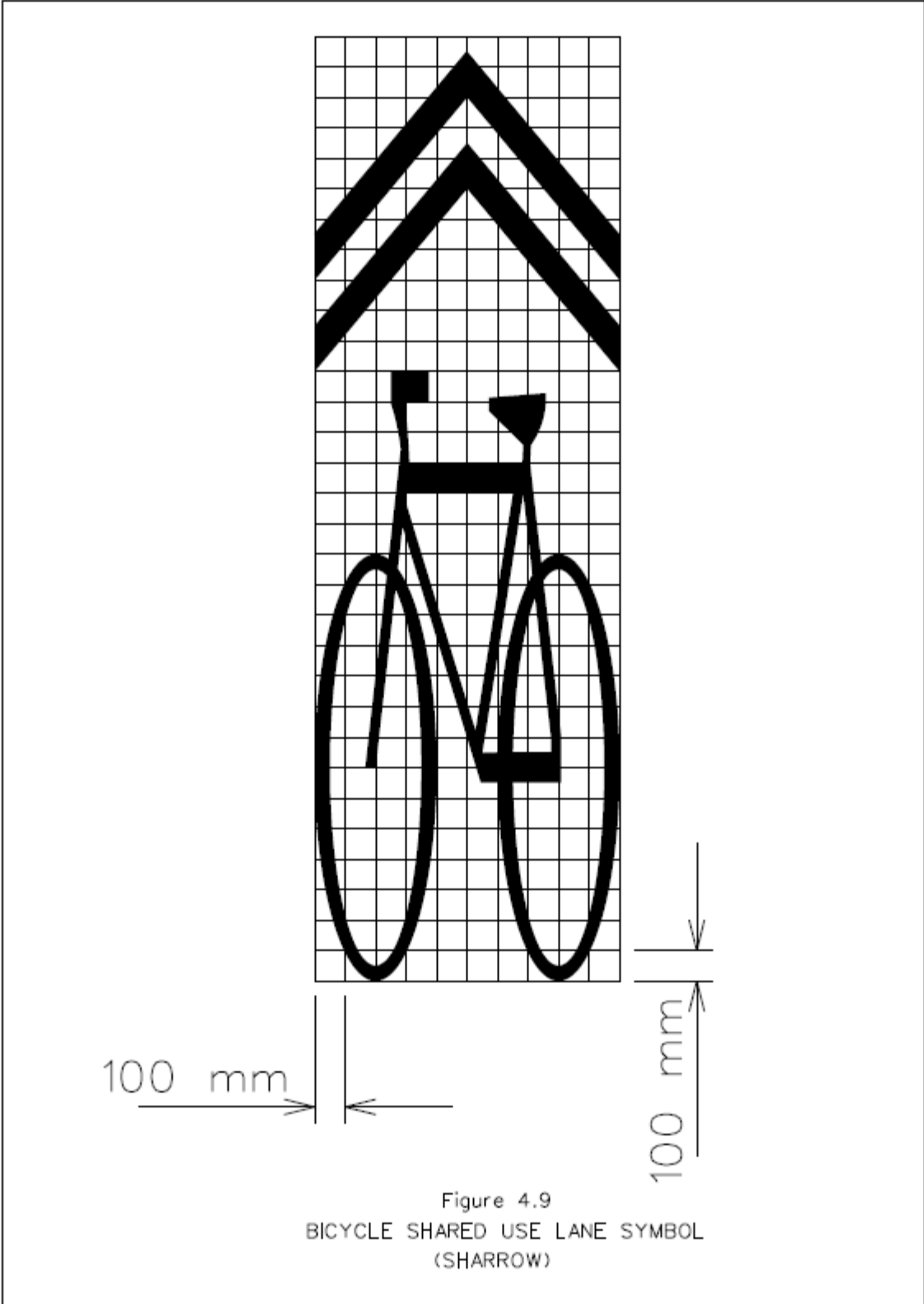


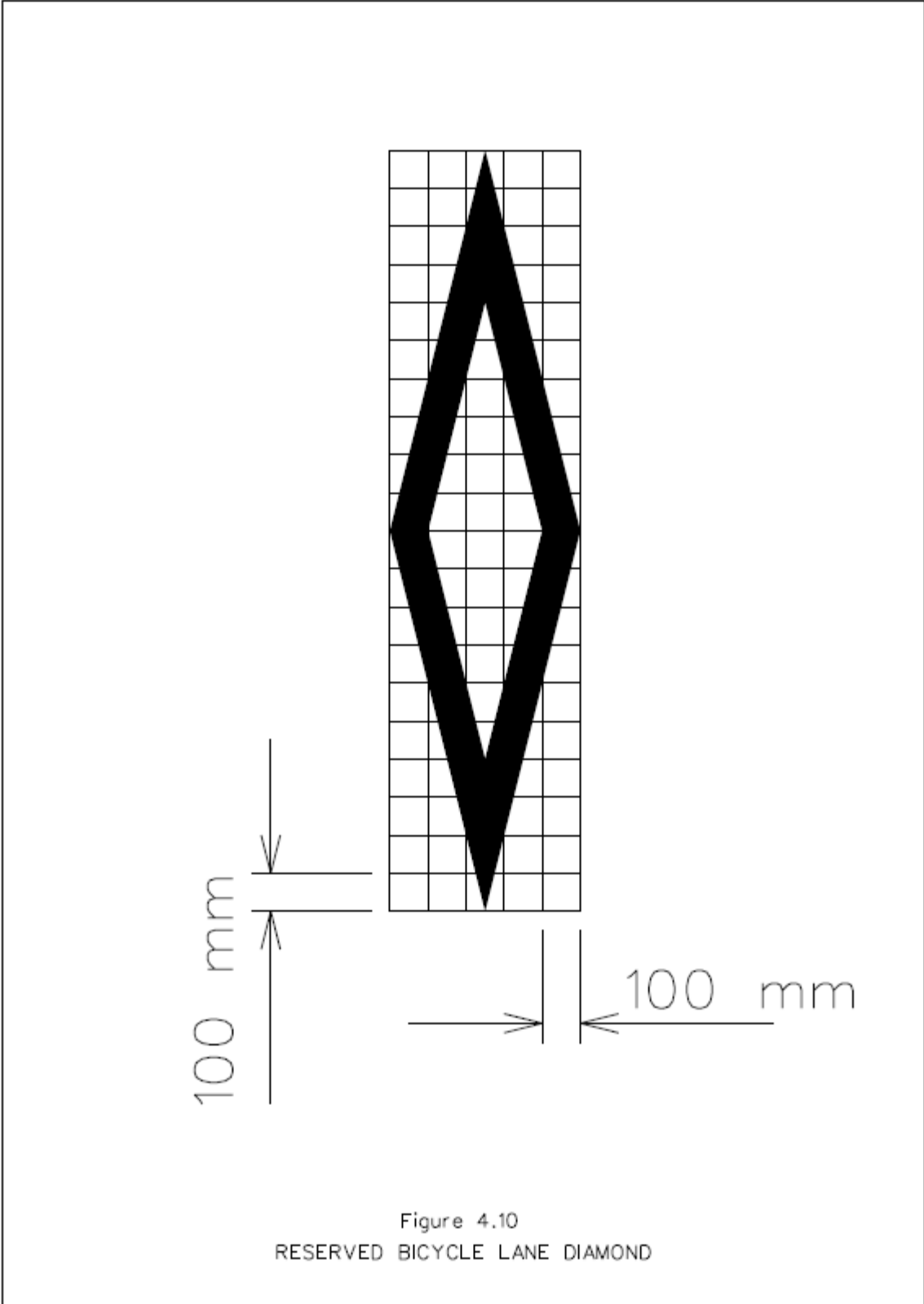
FIGURE 4.6

DIMENSIONS FOR MERGE ARROW









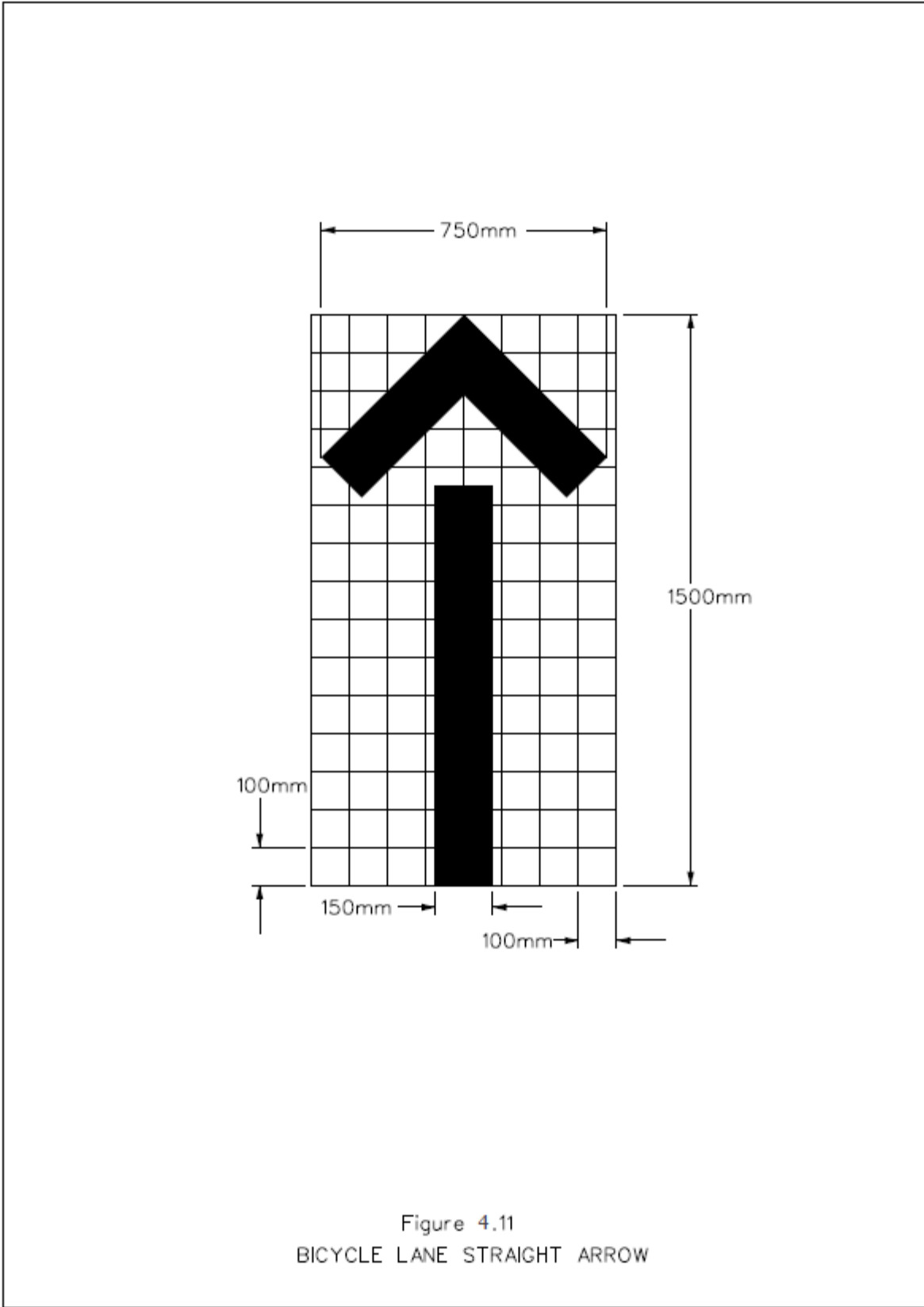


Figure 4.11
BICYCLE LANE STRAIGHT ARROW

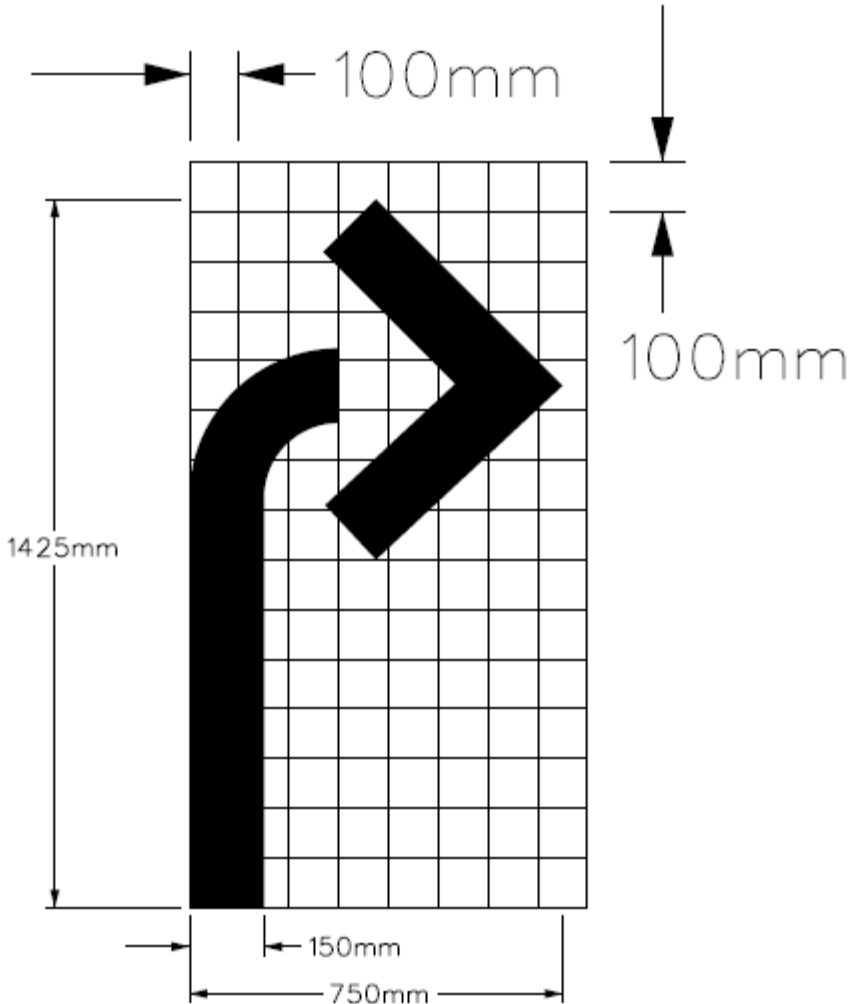


Figure 4.12
BICYCLE LANE TURN ARROW

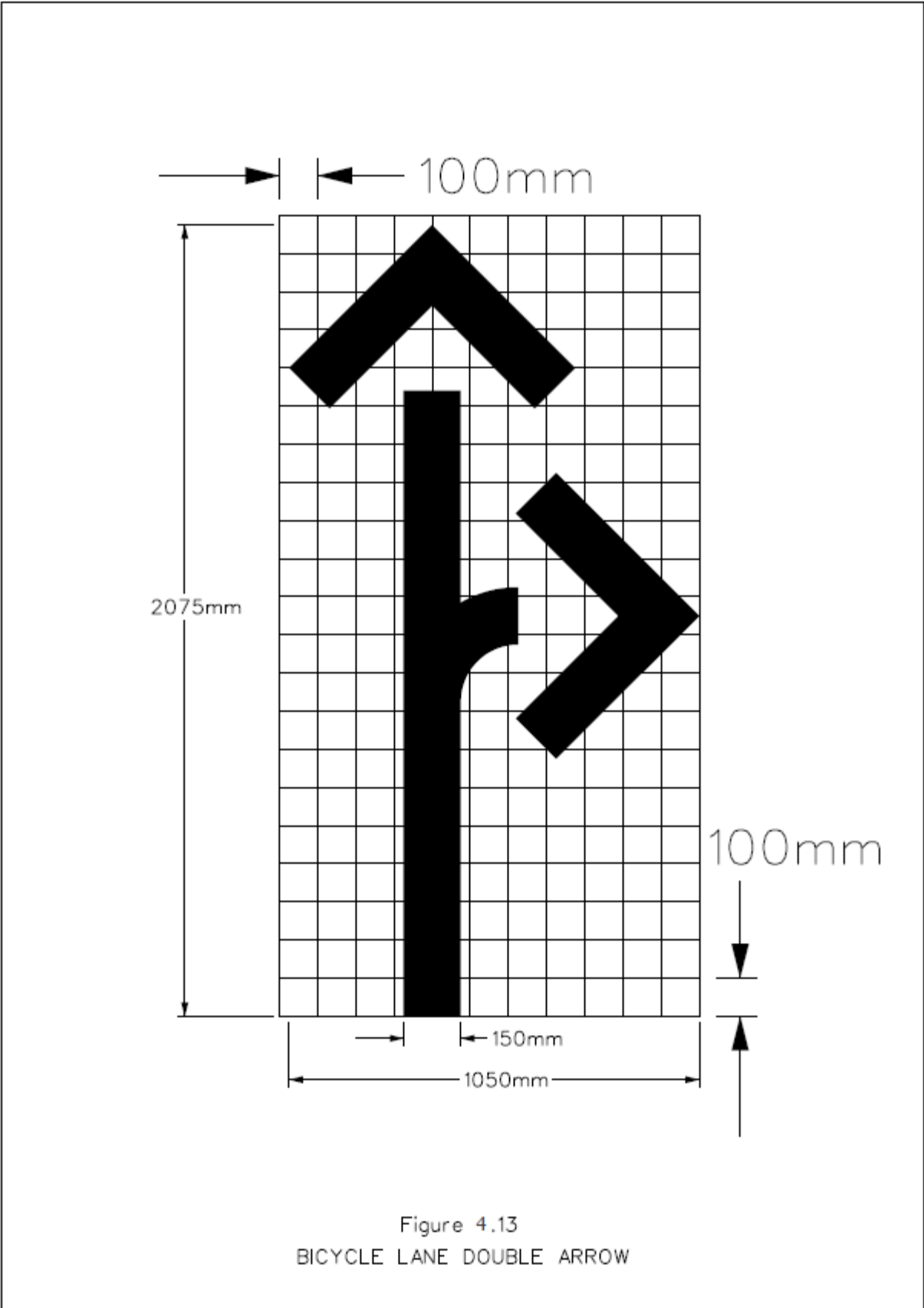


Figure 4.13
BICYCLE LANE DOUBLE ARROW

5.0 SPECIAL SITUATIONS

The following pavement markings do not belong to any of the previous categories and are shown here for completeness.

5.1 TRAFFIC CIRCLES

See Figure 5.1 for application.

The pavement marking lines in the traffic circle shall be:

- white in color.
- 10 cm in width.

A broken 3 m : 6 m secondary line shall be installed such that it guides the motorists;

- into the correct lane inside the traffic circle at the entrance to the traffic circle, and
- at each exit, to indicate the path into the proper lane leaving the traffic circle.

The solid pavement marking lines are to provide guidance to the motorist in the inside lane of the traffic circle and to discourage vehicle weaving maneuvers.

Zebra stripe pedestrian crosswalks shall be installed at each approach to and exit from the traffic circle.

5.2 PRIVATE DEVELOPERS

Private land developers are encouraged to conform with the City's Manual for Pavement Marking Design to avoid confusing or conflicting pavement marking applications at private property to City property transition areas.

5.3 PARK TRAILS

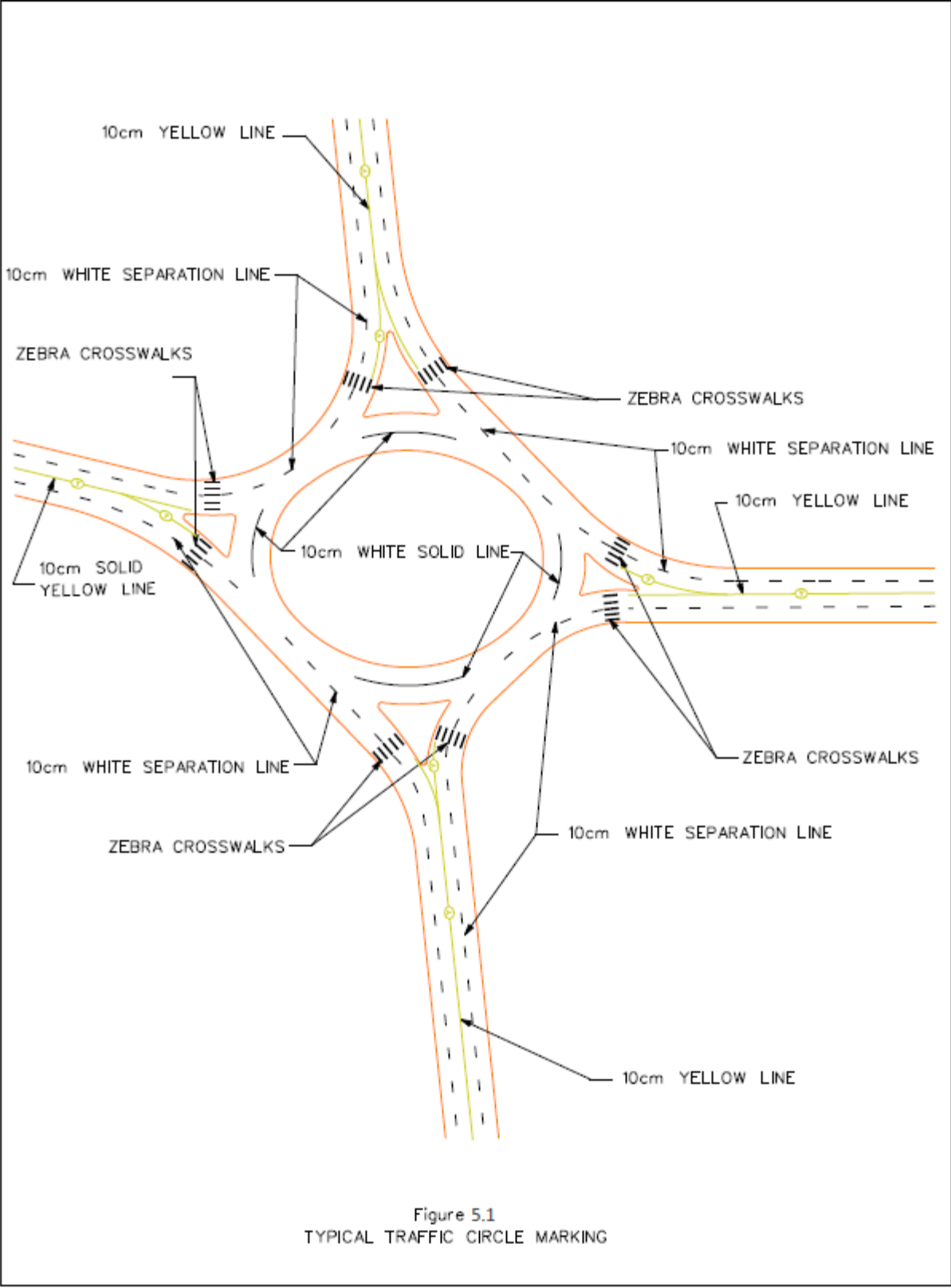
Operators of park trails are encouraged to conform with the City's Manual for Pavement Marking Design in order not to confuse park users at the transition area between park trails and City roadways.

5.4 RUMBLE STRIPS

Roadway rumble strips are made of 8 mm thick surface plastic.
These strips are placed :

- laterally across all lanes and shoulders in the travel direction under consideration, and
- each set of strips consists of 12 – 20 cm wide white lines, spaced at 30.9 cm intervals edge to edge.

See Figure 5.2.



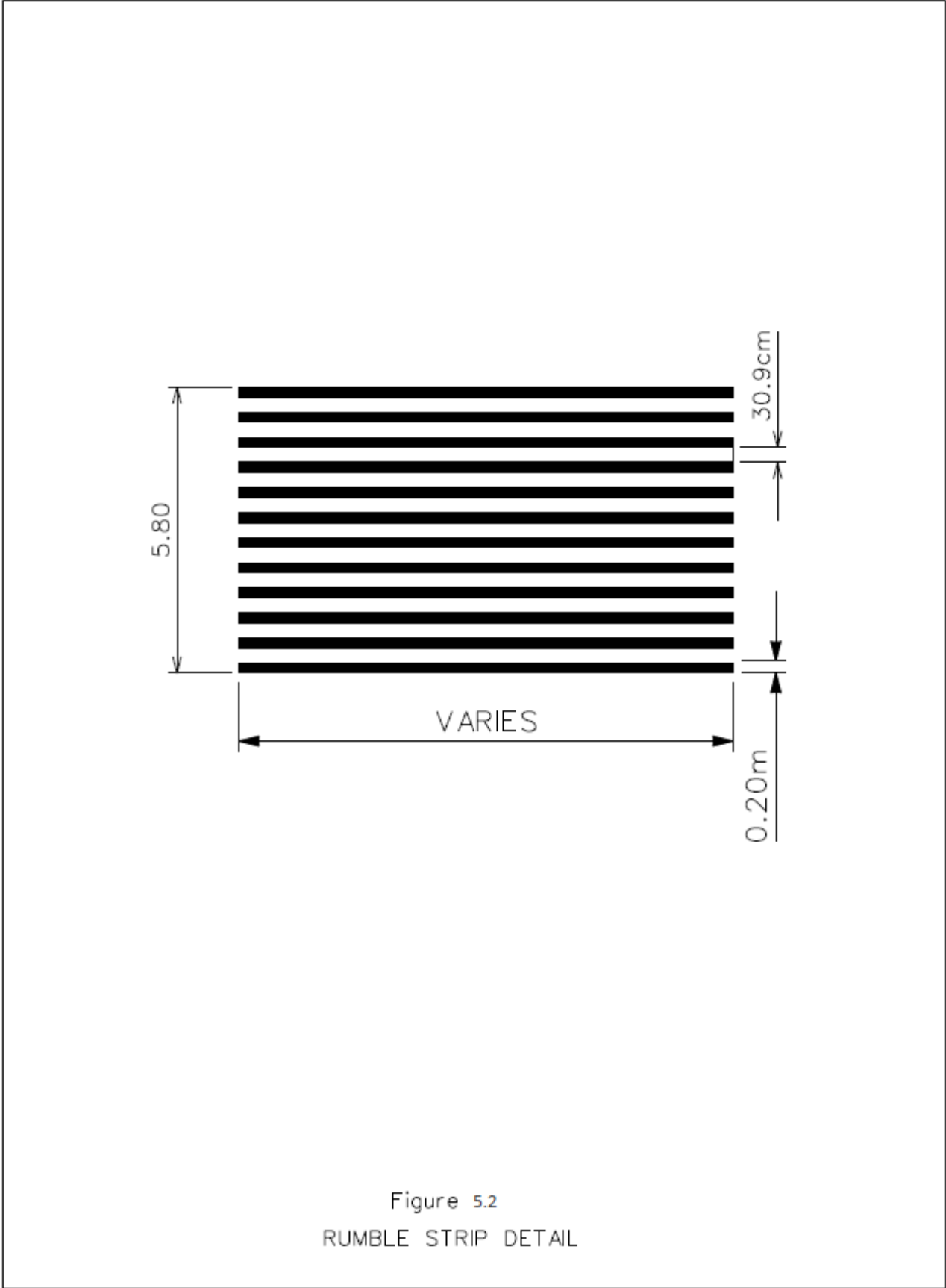


Figure 5.2
RUMBLE STRIP DETAIL

6.0 MATERIAL INSTALLATION

6.1 Definition

The City of Edmonton applies permanent plastic and spray material pavement markings on roads within the City of Edmonton.

All references made to paint markings in approved drawings shall mean permanent plastic or spray material markings as determined by the Director of Traffic Control.

6.2 Approvals

All permanent and spray material pavement marking materials to be applied on roads within the City of Edmonton must be approved by the Director of Traffic Control.

6.3 Contact

The City Operations Department, Traffic Operations Section must be contacted to verify the type of marking material being installed.

6.4 New Installations

The following are for the installation of permanent plastic and spray material pavement marking.

6.4.1 General Rules

- All shoulder lines, gore lines and arrows will be installed with an approved surface applied plastic.
- Shoulder lines will be installed with an approved in-laid applied plastic on all arterial roadways. All other shoulder lines will be installed with an approved surface applied plastic.
- All guide lines will be installed with an approved in-laid plastic.
- Detour roads or partially constructed roadways which will be in effect for one or more winters will have all critical markings (e.g. centre lines) and all other markings as identified by the Director of Traffic Control installed with an approved surface applied plastic.

6.4.2 Arterial Roads

- Arterial roads will have all lines installed with an approved in-laid plastic except gore lines.
- Arterial roads will have all gore lines installed with an approved surface applied plastic.

6.4.3 Collector and Local Roads

- Collector and Local roads will have all lines installed with an approved in-laid plastic except edgelines and gore lines.
- Collector and Local roads will have all edgelines and gore lines installed with an approved surface applied plastic.

6.4.4 Arrows, Words and Symbols

- Arrows will be installed with an approved in-laid plastic.
- All other words and symbols will be installed with an approved surface applied plastic.

6.5 MAINTENANCE

6.5.1 Hot Inlaid Plastic

- Maintenance will be required on all locations that are 5 years old or older and deemed degraded by the Traffic Operation's Pavement Marking Inspector and are not covered by warranty.
- These locations will be re-installed with a spray material and added to the annual maintenance program.

6.5.2 Surface Applied Plastic

- Maintenance will be required on all locations that are 3 years old or older and deemed degraded by the Traffic Operation's Pavement Marking Inspector and are not covered by warranty.
- These locations will be re-installed with a spray material and added to the annual maintenance program.

6.5.3 Patch Paving Locations

- If the existing pavement marking on either side of the patch paved area is marked with a spray material then the patch paved area will be re-installed with an approved in-laid plastic, surface applied plastic or spray material as identified by the Director of Traffic Control.
- If the existing pavement marking on either side of the patch paved area is marked with an in-laid plastic then the patch paved area will be re-installed with an approved in-laid plastic.
- If the existing pavement marking on either side of the patch paved area is marked with a surface applied plastic then the patch paved area will be re-installed with an approved surface applied plastic.
- All guide lines in a patch paved area will be re-installed with an approved in-laid plastic.
- If a total intersection is patch paved it will be re-installed with an approved in-laid plastic.



7.0 CONSTRUCTION SPECIFICATIONS INDEX

<u>Section</u>	<u>Title</u>	<u>Issued</u>	<u>Page Nu.</u>
02760	Plastic Pavement Markings	April 2012	78
02761	Glass Beads	April 2012	83
02762	Traffic Paint	April 2012	87
02763	Water Borne Traffic Paint	April 2012	93
02764	Crosswalk and Stopline Painting	January 1996	100
02765	Lane Markings - Hot Applied Paint	February 1997	102
02767	Prefabricated Road Marking Material	April 2012	104
02768	MMA Spray Plastic	February 2000	110

1.0 GENERAL

1.1 SECTION INCLUDES

- 1.1.1 Supply and application of cold plastic marking on asphalt or concrete pavement.
- 1.1.2 Supply and application of MMA spray plastic on asphalt or concrete pavement.
- 1.1.3 Supply and application of hot thermoplastic marking on asphalt pavement.

1.2 RELATED SECTIONS

- Section 02761 Dual Coated Glass beads
- Section 02768 Methyl Methacrylate (MMA) Spray Plastic.

1.3 REFERENCES

- ASTM D4060 – Test Method for Abrasion Resistance of Organic Coatings by the Taber Abraser.
- ASTM D256 - Test Methods for Determining the Izod Pendulum Impact Resistance of Plastics.
- ASTM D570 - Test Method for Water Absorption of Plastics.
- ASTM E28 - Test Methods for Softening Point of Resins Derived from Naval Stores by Ring and Ball Apparatus.
- ASTM E1347 - Test Method for Color and Color-Difference Measurement by Tristimulus Colorimetry.

2. PRODUCTS

2.1 MATERIALS

- 2.1.1 **MMA Spray Plastic:** shall conform to specification Section 02768.
- 2.1.2 **Cold Plastic Markings:** two-component, cold-extruded and cold-curing, having a specific gravity of 1.9 minimum at 25° C, and conforming to paragraph 2.1.4 below.
- 2.1.3 **Hot Thermoplastic Marking:** hot-extruded, having a specific gravity of 1.95 minimum at 25° C for white-coloured markings and 1.90 minimum at 25° C for yellow-coloured markings, and having softening points of 110° C minimum for both coloured markings according to ASTM E28. Both coloured markings will also conform to paragraph 2.1.4 below.
- 2.1.4 Both cold and hot plastic markings shall conform to the following, unless otherwise stated.
 - 2.1.4.1 **Water Absorption:** 0.5% maximum by mass retained water after 24-hour immersion, according to ASTM D570 Procedure A.
 - 2.1.4.2 **Impact Resistance:** minimum 1.13 J at 25° C when material is cast into bar 25 mm² cross-section by 75 mm long, with 25 mm extended above vice jaws in a cantilever beam (Izod type) tester using the 2.82 J scale, according to ASTM D256 Method C.
 - 2.1.4.3 **Abrasion Resistance:** For hot thermoplastic markings only, maximum weight loss of 0.60 g when subjected to 200 revolutions on Taber abrader at 25° C using H-22 Calibrade wheels weighted to 500 g with sample kept continuously wet with distilled water. Prepare test sample with representative material placed on 100 mm square plate, 3±0.1 mm thick.

2.1.4.4 Chemical Resistance: Test sample of 25 cm², no degradation after exposure to:

24 hour immersion in 5% NaCl.

24 hour immersion in 5% CaCl.

1 hour spot test with mineral oil.

2.1.4.5 No deterioration when in direct contact with asphalt cement in asphalt materials, or with sodium chloride, calcium chloride or other de-icing chemicals.

2.1.4.6 Non-toxic and not harmful to persons or property when in hardened state.

2.1.4.7 No discoloration from sunlight ultraviolet exposure and no bond failure for warranted life of material.

2.1.5 Glass Beads: shall conform to specification Section 02761.

2.1.6 Pre-marking Paint: As approved by the Engineer.

2.1.7 Groove Filler: LRS 424 or approved equal.

2.2 MIX FORMULATION

2.2.1 White Colour: conforming to U.S. Federal Standard 595B Colour Number 37925 or **CGSB 1-GP-12.1C**, 70% minimum when measured with the Colour Guide Reflectometer 0,45° daylight luminous directional reflectance, with a green filter.

2.2.2 Yellow Colour: conforming to U.S. Federal Standard 595B Colour Number 33538 or **CGSB colour #505-308**, 40% minimum when measured with the Colour Guide Reflectometer 0,45° daylight luminous directional reflectance, with a green filter.

The tolerance in colour allowed is as follows in the CIE L*, a*, b* Uniform Color Space and Color Difference Equation when calculated from instrumentally measured colour differences conforming to ASTM D2244:

White	L* = +2 and -1.5 max a* = +1.5 and -1 max b* = +4 and -4 max
-------	--

Yellow - MTO	L* = +2 and -1.5 max a* = +1.5 and -1 max b* = +4 and -4 max
--------------	--

Yellow - U.S.	L* = -2 and +4 max a* = -6 and +4 max b* = -9 and +10 max
---------------	---

2.2.3 No formulation change unless approved by the Engineer. Any significant change will be subject to field trials.

2.3 EQUIPMENT

Grooving Machine, Applicators: subject to the Engineer's approval.

3. EXECUTION

3.1 PREPARATION

- 3.1.1 Follow safe practices in the Manual of Temporary Traffic Control.
- 3.1.2 Sweep or airblow pavement surface clean and dry.
- 3.1.3 Remove conflicting markings.
- 3.1.4 Do not apply plastic marking until pre-markings have passed inspection by the Engineer or their designate.

3.2 MMA SPRAY PLASTIC APPLICATION

- 3.2.1 Mix components and apply MMA plastic markings according to manufacturer's surface application procedures, to a minimum thickness of 0.5 mm.
- 3.2.2 Apply plastic markings in accordance with manufacturer's instructions and procedures.
- 3.2.3 Apply glass beads to surface of material before it has set, at a rate of 140 to 250 g/m².
- 3.2.4 Do not permit traffic over applied markings until they have adequately hardened.

3.3 COLD PLASTIC APPLICATION

- 3.3.1 Mix components and apply cold plastic marking according to manufacturer's surface application procedure, to a thickness of 2.0 mm minimum and 3.0 mm maximum.
- 3.3.2 Apply plastic markings in accordance with manufacturer's instructions and procedures.
- 3.3.3 Apply glass beads to surface of extruded material before it has set, at a rate of 140 to 250 g/m².
- 3.3.4 Do not permit traffic over applied markings until they have adequately hardened.

3.4 HOT THERMOPLASTIC APPLICATION

- 3.4.1 Cut groove into pavement surface to designated width and depth. Remove grindings and haul to a designated location. Sweep or airblast groove clean and dry.
- 3.4.2 Heat material and apply according to manufacturer's hot extrusion process.
- 3.4.3 Apply plastic markings in accordance with manufacturer's instructions and procedures.
- 3.4.4 Fill groove with hot molten material. Do not overfill more than 3.0 mm above pavement surface.
- 3.4.5 Apply glass beads to surface of extruded material while it is still molten at a rate of 140 to 250 g/m².
- 3.4.6 Trim surplus material to give clean straight edges.
- 3.4.7 Do not permit traffic over applied markings until they have adequately hardened.

3.5 PROTECTION AND CLEANUP

- 3.5.1 Protect surrounding areas and structures from disfiguration and damage. Repair any damage as directed by the Engineer or their designate.
- 3.5.2 On completion of work and prior to opening to traffic, clean up and leave site free of debris and waste matter.

3.6 THICKNESS TOLERANCE

3.6.1 MMA Spray Marking

3.6.1.1 Measurement: The quality assurance laboratory will measure suspect markings with a thickness gauge instrument. The average of 5 measurements will represent 300 m of marking, or one job site, whichever is less.

3.6.1.2 Thickness Deficiencies: Where a significant number of deficiencies occur in the work, involving average thicknesses less than 0.5 mm, the Engineer may order removal and replacement or application of additional material.

3.6.2 Cold Plastic Marking

3.6.2.1 Measurement: The quality assurance laboratory will measure suspect markings with a surface caliper. The average of 5 measurements will represent 300 m of marking, or one job site, whichever is less.

3.6.2.2 Thickness Deficiencies: Where a significant number of deficiencies occur in the work, involving average thicknesses greater than 3.0 mm or less than 1.8 mm, the Engineer may order removal and replacement or application of additional material.

3.6.2.3 If surface dishing deeper than 0.5 mm occurs, the Engineer may order removal and replacement. Variations in asphalt surface profile may be taken into consideration.

3.6.3 Thermoplastic Marking

3.6.3.1 Measurement: The quality assurance laboratory will core suspect markings. The average thickness of 3 cores will represent 300 m of marking, or one job site, whichever is less.

3.6.3.2 Overfill Thickness: That portion of marking above pavement surface will receive no additional payment. If overfill exceeds 3.0 mm, the Engineer may order removal and replacement of marking.

3.6.3.3 Groove Thickness Deficiencies: Where a significant number of deficiencies occur, involving average groove thicknesses less than 70% of that specified, the Engineer may order removal and replacement.

3.6.3.4 If surface dishing deeper than 0.5 mm occurs, the Engineer may order removal and replacement. Variations in asphalt surface profile may be taken into consideration.

3.7 WIDTH TOLERANCE

3.7.1 MMA Spray Marking

The quality assurance laboratory will determine the width of suspect markings by the average of 5 measurements representing 300 m of marking, or one job site, whichever is less.

3.7.2 Cold Plastic Marking

The quality assurance laboratory will determine the width of suspect markings by the average of 5 measurements representing 300 m of marking, or one job site, whichever is less.

3.7.3 Hot Thermoplastic Marking

The quality assurance laboratory will determine the groove width of suspect markings by the average measurements of 3 cores representing 300 m of marking, or one job site, whichever is less.

3.7.4 Width Deficiencies

Where a significant number of deficiencies occur greater than 10 mm in average widths of cold plastic, or in average groove widths of hot thermoplastic, the Engineer may order removal and replacement.

END OF SECTION



— Page Left Intentionally Blank —

Construction Specifications	Section 02761 Glass Beads	April 2012
------------------------------------	--------------------------------------	-------------------

1. GENERAL

1.1 SECTION INCLUDES

Requirements for the supply only of glass beads for traffic marking.

1.2 REFERENCES

ASTM D1155 – Test Method for Roundness of Glass Spheres
ASTM D1214 - Test Method for Sieve Analysis for Glass Spheres.

ASTM E11 – Specification for Woven Wire Sieve Cloth and Test Sieves

CGSB 1-GP-71 Method 49.1 - Test Method for Index of Refraction on Glass Beads.

2. PRODUCT

2.1 MATERIAL

2.1.1 Glass Beads: Shall be manufactured from glass of a composition designed to be highly resistant to the effects of traffic wear and weathering. Glass beads shall not contain lead or be manufactured from materials containing lead.

2.1.1.1 Color:

The glass shall be colourless to a degree that the resulting beads, when added to white paint, do not impart a noticeable hue.

2.1.1.2 Bead type and Grade:

Beads supplied shall be treated in such a manner as to overcome the effects of water, as vapour or liquid, on the beads before the beads are added to the paint stripe.

2.1.1.3 Roundness:

A minimum of 80% by mass of the glass beads shall be true spheres.

2.1.1.4 Gradation:

The glass beads for mixing with and for surface application on thermoplastic material shall meet the following gradation requirements when tested in accordance with ASTM D1214:

Sieve Size (µm)	% Passing by Mass
850	90 - 100
300	15 - 50
180	0 - 10

2.1.1.5 Index of Refraction:

1.5 minimum when tested in liquid immersion at 25° C according to CGSB 1-GP-71 Method 49.1.

2.1.1.6 Imperfections:

The surface of the beads shall be smooth, lustrous and free from film, scratches and pits.

Not more than 25% by mass of the true spheres shall have imperfections such as milkiness, dark specks, incipient fractures, and air inclusions in the form of bubbles greater than 10% of the volume of the spheres.

2.2 Quality Assurance Sampling and Testing

Sampling and testing of the glass beads supplied to the project will be carried out by the Quality Assurance laboratory.

A maximum of 10% but no less than 1% of the total number of packages in each batch will be taken at random for test purposes. The contents of each random package will be riffled until a representative sample of approximately 1000 g (or 500 ml) of beads is obtained. The 1000 g samples will be combined to form a composite sample of about 4 kg (about 4 L in volume) representing a batch of 25,000 kg of beads. The composite sample will be riffled in the laboratory until about a 150 g sample is obtained for the following testing.

2.2.1 Roundness Testing:

The percentage true spheres shall be determined by one of the following methods:

(a) By counting the beads under 50X and 100X magnification as follows:

- Glass beads larger than #50 sieve size inclusive, shall be counted using 50X magnification (see gradation requirements).
- Glass beads smaller than #50 sieve size shall be counted using 100X magnification.
- Approximately 1,000 beads contained loosely in a culture dish shall be counted under reflected light for each sieve specified to determine the percentage by mass of perfectly round spheres.

(b) By ASTM D1155

2.2.2 Imperfections Testing:

Imperfections shall be evaluated by observation using 50X and 100X magnification.

2.2.3 Water Resistance Testing:

One hundred grams of glass beads will be placed in a 500 ml beaker and an equivalent volume of distilled water will be flowed into the beaker on top of the glass beads. The beaker will be permitted to stand for 5 min. At the end of this period, the water shall be poured off and the glass beads will be transferred to a clean, dry beaker and permitted to stand for 5 min. The spheres will then be introduced into a standard 125 mm diameter glass funnel having a stem of 125 mm length. The beads shall flow through the funnel without stoppage. (Slight initial agitation to start the flow through the funnel at the beginning of the test will be permissible.)

3. EXECUTION

3.1 PACKAGING

Beads in bags shall be free of clusters, lumps, moisture and foreign matter.

Glass beads shall be packaged in bags of 25 kg net capacity, and each bag shall be marked to show clearly the following information:

- i. "Overlay Type Glass Beads"
- ii. "Moisture Proof Grade"
- iii. "MTC"
- iv. "Batch number" (marked in 25 mm
- v. "Manufacturer's name" high letters)

Bags shall be paper-lined burlap with 50 µm polyethylene inserts. The burlap liner, all seams and top closures shall be waterproof and leakproof and shall be capable of maintaining these properties during transportation and numerous handlings.

Bags shall be approximately 0.35 m x 0.66 m with the 50 µm polyethylene insert being 0.35 m x 0.96 m.

3.2 DELIVERY

Deliver Glass Beads to designated location in pallets for unloading by forklift.

Pick up rejected shipment and replace with glass beads from another production batch.

END OF SECTION



— Page Left Intentionally Blank —

1. GENERAL

1.1 SECTION INCLUDES

Supply of paint for traffic marking on asphalt or concrete pavement.

1.2 REFERENCES

1.2.1

The most recent revisions of the following specifications, test methods and standards form a part of this specification where referenced:

ASTM D713 - Practice for Conducting Road Service Tests on Fluid Traffic Marking Materials.

ASTM D868 - Practice for Determination of Degree of Bleeding of Traffic Paint.

ASTM D913 – Practice for Evaluating Degree of Traffic Paint Line Wear.

ASTM D969 – Test Method for Laboratory Determination of Degree of Bleeding of Traffic Paint.

ASTM D1394 – Test Methods for Chemical Analysis of White Titanium Pigments.

ASTM E1347 - Test Method for Colour and Colour Difference Measurement by Tristimulus Colorimetry.

CGSB 1-GP-12.C - Standard Paint Colours.

CGSB 1-GP-71 - Methods of Testing Paints and Pigments.

U.S. FED-STD-595B Dec. 15, 1989 - Colours Used in Government Procurement

CIE 1976 - L*, a*, b* Uniform Colour Space and Colour Difference Equation.

2. PRODUCTS

2.1 MATERIALS

2.1.1 General

2.1.1.1 Traffic paint: hot applied, white or yellow; applicable on asphalt and concrete pavement surfaces shall be homogeneous, and shall be well ground to a uniform smooth consistency and properly dispersed in the vehicle. It shall be free from skin, dirt and other foreign particles; settled pigment shall be easily redispersed with minimum resistance to form a smooth uniform product of proper consistency and shall be capable of being sprayed at the temperature intended for the paint. The traffic paint shall flow evenly and smoothly and cover solidly when applied to pavements.

2.1.1.2 Paint shall be guaranteed to retain the properties specified for 12 months after acceptance by the engineer

2.1.1.3 Paint shall be guaranteed not to skin, gel, or cake in containers when stored outside under summer and winter conditions for 12 months after delivery.

2.1.1.4 The materials used in the manufacture of the traffic paint shall be of high quality and consistency such that the appearance will not change in service to impair the colour or visibility of the delineation. The traffic paint film shall be flat in finish, and the white and yellow markings shall be visible under daylight and artificial light..

2.1.1.5 Traffic paint shall meet the requirements detailed in Table 02762.1.

2.1.2 Colour

The traffic paint shall conform to the following colour requirements:

2.1.2.1 White – White Paint: Federal Standard 595 Colour #37925; or CGSB 1-GP-12.1C, White 513-301.

2.1.2.2 Yellow - Yellow Paint: Federal Standard 595, Colour #33538; or CGSB colour # 505-308.

2.1.2.3 The tolerance in colour allowed is as follows in the CIE L*, a*, b* Uniform Colour Space and Colour Difference Equation when calculated from instrumentally measured colour differences conforming to ASTM D 2244:

White	L* = +2 and -1.5 max a* = +1.5 and -1 max b* = +4 and -4 max
-------	--

Yellow - MTO	L* = +2 and -1.5 max a* = +1.5 and -1 max b* = +4 and -4 max
--------------	--

Yellow - U.S.	L* = -2 and +4 max a* = -6 and +4 max b* = -9 and +10 max
---------------	---

2.1.3 **Cleaner Solvent:** As specified by paint manufacturer.

2.1.3.1 Free from dirt, sand, or other foreign matter that can clog screens, valves, pumps, or other devices used in a paint stripping apparatus

2.1.3.2 Paint pigment shall be well ground and properly dispersed in the vehicle. Settled pigment shall be easily redispersed with minimum resistance to form a smooth uniform product of proper consistency and capable of being sprayed at temperature intended.

2.1.3.3 Paint shall be guaranteed to retain the properties in paragraphs 2.1.3.1 and 2.1.3.2 above for 12 months after acceptance by the Engineer.

2.1.3.4 Paint shall be guaranteed not to skin, gel, or cake in containers when stored outside under summer and winter conditions for 12 months after delivery.

2.1.4 **Chemical Composition:** The chemical composition of the traffic paint shall be at the discretion of the paint manufacturer, but any changes after the tender period must be communicated to the City of Edmonton in writing immediately along with documentation that these changes do not affect the performance of the materials.

2.2 PREQUALIFYING QUALITY ASSURANCE

2.2.1 The quality assurance laboratory will conduct pre-qualifying tests described in the following paragraphs.

2.2.2 Samples

2.2.2.1 Submit samples of paint when requested by the quality assurance laboratory.

2.2.2.2 Deliver a minimum of two 4 litre cans of each paint to be tested. Label each can clearly with manufacturer's name and code number. Affix labels that can easily be removed after arrival at the quality assurance laboratory.

2.2.2.3 Submit a complete paint data form, obtainable from Engineer, for each test sample. Test samples without accompanying paint data forms will not be considered.

2.2.3 **Preliminary Laboratory Tests:** Paint samples will be tested for drying time and colour before field trials. Samples failing preliminary tests will be rejected for further testing.

2.2.4 Field Tests

2.2.4.1 Paint samples will be applied on asphalt or concrete pavement, and will be evaluated for uniformity of application, overspray, covering properties and drying time.

2.2.4.2 Road applied paint will be evaluated according to ASTM D713 for general appearance, colour, luminous directional reflectance and abrasion resistance.

2.2.5 Overall suitability of paint will be based on results of field tests and compliance with other requirements of this section.

2.3 QUALITY ASSURANCE FOR SUPPLY

2.3.1 Supply paint having the same physical and chemical properties as the samples that passed the pre-qualifying quality tests.

2.3.2 The quality assurance laboratory will take and test samples from any shipment or batch of paint.

2.3.3 If supply samples do not meet specifications, the Engineer will reject the shipment and corresponding production batch.

3. EXECUTION

3.1 PACKAGING

- 3.1.1 Prepare paint at factory ready for application. Place in containers that are properly sealed, showing no sign of leakage, and are of the following sizes as specified:
 - 3.1.1.1 **20-Litre Drum:** Round, minimum 24 gauge steel, with properly fitting lid and seal.
 - 3.1.1.2 **205-Litre Drum:** Round, minimum 18 gauge steel, with 50mm bung.
- 3.1.2 Mark each container with weather resistant labels showing:
 - 3.1.2.1 Colour and type of paint.
 - 3.1.2.2 Manufacturer's name and address.
 - 3.1.2.3 Manufacturer's code and batch numbers.
 - 3.1.2.4 Date of filling container.
 - 3.1.2.5 Volume of container in litres.

3.2 DELIVERY

- 3.2.1 Deliver paint to designated location in pallets for unloading by forklift.
- 3.2.2 Pick up rejected shipment and replace with paint from another production batch.
- 3.2.3 Pick up emptied containers which remain the property of manufacturer.

TABLE 02762.1 TRAFFIC PAINT REQUIREMENTS

Tests	Minimum Requirements	Maximum Requirements	Test Method CGSB 1-G P71	Test Method ASTM
Abrasion resistance * (maximum loss, mg)		50		D4060
Bleeding ratio **	0.95			
Consistency (kreb units)				
at 23° ± 1°C	80	95	4.5	
at 7° ± 1°C		125	4.5	
Drying time (minutes) at 23° ± 1°C		3	5.1	
Fineness of grind (Hegman)	3			D1210
Total nonvolatiles (% by mass)	68	72		
Pigment content (% by mass)	49	53	21	
Prime pigment T102 or PbCrO4 (% by mass)	10			D1364 /D126
Reflectance (%)				
White paint	80			E1347
Yellow paint	50			E1347
Settling (12 months)	8			D869
Water (%)		0.5	24.1	

* Abrasion resistance, average of 3 test samples prepared as follows: 15±1 mil wet film thickness applied to steel test plates, air dried for 30 minutes, then baked at 70°C for 48 hours; test plates are then cleaned, weighed and tested for 1000 cycles using a Taber Abrader operated with 500g load and CS-10 abrader wheels.

** Bleeding ratio based on U.S Federal Specification TT-P-85d, asphalt felt to conform to U.S Federal Specification HH-F-191.

END OF SECTION



— Page Left Intentionally Blank —

1. GENERAL

1.1 SECTION INCLUDES

- 1.1.1 Supply of water-borne paint for traffic marking on asphalt or concrete pavement.

1.2 REFERENCES

- 1.2.1 The most recent revisions of the following specifications, test methods and standards form a part of this specification where referenced:

ASTM D185 – Test Methods for Coarse Particles in Pigments

ASTM D562 – Test Method for Consistency of Paints Measuring Krebs Unit (KU) Viscosity Using the Stormer Type Viscometer

ASTM D711 – Test Method for No Pick Up Time of Traffic Paint

ASTM D713 – Practice for Conducting Road Service Tests on Fluid Traffic Marking Materials

ASTM D868 – Practice for Determination of Degree of Bleeding of Traffic Paint

ASTM D869 – Test Method for Evaluating Degree of Setting of Paint

ASTM D969 – Test Method for Laboratory Determination of Degree of Bleeding of Traffic Paint

ASTM D2205 – Guide for Selection of Tests for Traffic Paints

ASTM D2243 – Test Method for Freeze Thaw Resistance of Water Borne Coatings

ASTM D2244 – Practice for Calculation of Color Tolerances and Color Differences from Instrumentally Measured Color Coordinates

ASTM D2369 – Test Method for Volatile Content of Coatings

ASTM D3168 – Practice for Qualitative Identification of Polymers in Emulsion Paints

ASTM D3960 – Practice for Determining Volatile Organic Compound (VOC) Content of Paints and Related Coatings

ASTM E70 – Test Method for pH of Aqueous Solutions With the Glass Electrode

ASTM E303 – Test Method for Measuring Surface Frictional Properties Using the British Pendulum Tester

ASTM E1347 – Test Method for Color and Color-Difference Measurement by Tristimulus Colorimetry

CGSB 1-GP-12.C – Standard Paint Colors

CGSB 1-GP-71 – Methods of Testing Paints and Pigments

U.S. FED-STD-595B Dec. 15, 1989 - Colors Used in Government Procurement

CIE 1976 - L*, a*, b* Uniform Colour Space and Colour Difference Equation.

2. PRODUCTS

2.1 MATERIALS

2.1.1 General

- 2.1.1.1 Water-borne traffic paint shall be homogeneous, and shall be well ground to a uniform smooth consistency and properly dispersed in the vehicle. It shall be free from skin, dirt and other foreign particles; settled pigment shall be easily redispersed with minimum resistance to form a smooth uniform product of proper consistency and shall be capable of being sprayed at the temperature intended for the paint. The water-borne traffic paint shall flow evenly and smoothly and cover solidly when applied to pavements.
- 2.1.1.2 Paint shall be guaranteed to retain the properties specified for 12 Months after acceptance by the Engineer
- 2.1.1.3 Paint shall be guaranteed not to skin, gel, or cake in containers when stored outside under summer and winter conditions for 12 months after delivery.
- 2.1.1.4 The materials used in the manufacture of the water-borne traffic paint shall be of high quality and consistency such that the appearance will not change in service to impair the colour or visibility of the delineation. The water-borne traffic paint film shall be flat in finish, and the white and yellow markings shall be visible under daylight and artificial light after the addition of the overlay glass beads.

2.1.2 Colour

The water-borne traffic paint shall conform to the following colour requirements:

- 2.1.2.1 White – White Paint: Federal Standard 595 Color #37925; or CGSB 1-GP-12.1C, White 513-301.
- 2.1.2.2 Yellow - Yellow Paint: Federal Standard 595, Colour #33538; or CGSB Colour #505-308.
- 2.1.2.3 The tolerance in colour allowed is as follows in the CIE L*, a*, b* Uniform Colour Space and Colour Difference Equation when calculated from instrumentally measured colour differences conforming to ASTM D 2244:

White	L* = +2 and -1.5 max a* = +1.5 and -1 max b* = +4 and -4 max
Yellow - MTO	L* = +2 and -1.5 max a* = +1.5 and -1 max b* = +4 and -4 max
Yellow - U.S.	L* = -2 and +4 max a* = -6 and +4 max b* = -9 and +10 max

2.1.3 Chemical Composition

- 2.1.3.1 The chemical composition of the water-borne traffic paint shall be at the discretion of the paint manufacturer, but any changes after the tender period must be communicated to the City of Edmonton in writing immediately along with documentation that these changes do not affect the performance of the materials.



2.1.4 ReflectORIZATION

2.1.4.1 The white and yellow paints shall be used with overlay glass beads which are applied uniformly after application of the paint at a rate as shown below. The white and yellow paints shall provide proper anchorage for overlay glass beads conforming to the City of Edmonton Specification Section 02761.

Rate of application for overlay Glass Beads per litre of Traffic Paint

% Volume Solids of Traffic Paint	Glass Beads Required in kg
40-56	0.7
57-70	0.8

2.1.5 Physical Property Requirements

2.1.5.1 Water-borne traffic paints shall be supplied ready-mixed for use without any addition of water.

2.1.5.2 The handling and storage qualities must be acceptable with respect to degree of settling, uniform consistency, absence of skinning, and thixotropic properties. The water-borne traffic paint shall be capable of being sufficiently atomized to produce a uniformly applied paint stripe without side splatter and overspray within the limitation imposed by conventional striping equipment.

2.1.5.3 The physical properties of the water-borne traffic paints submitted for compliance certification shall conform to Table 1.

Table 1: Physical Property Requirements for Water-Borne Traffic Paint

Test and Property	Requirements		TEST METHODS		
	Min	Max	CGSB 1-GP-71	ASTM	Other
Volatile Organic Content %		8.5		D 3960	
Settling 6 months	8.0			D869	
Hiding Power m ² /l	8.4				Pfund cyptometer with #3.5 wedge
Skinning 48 hours	nil	nil	10.1		
Viscosity KU @ 7°C @ 25°C	85	135.0 110.0	4.5	D562	
Viscosity Change after Heat-Shear Stability Test at 25°C KU					Caltrans 8010-61G-30
Freeze-Thaw Stability	pass			D2243	
Coarse Particles # 60 sieve - 250 µm #100 sieve - 150 µm	nil	nil 0.01		D185 & D2205	
No Pickup Time, mins.		8.0*		D711	
Directional Reflectance % White Paint Yellow Paint	70.0 50.0			E97	
Skid Resistance BPN Units	**			E303	

- *For coning type of traffic paints, this value can be higher.

2.2 QUALITY CONTROL

- 2.2.1 The Manufacturer shall be responsible for carrying out a quality control program to ensure that the water-borne traffic paint(s) conform(s) to this specification. Results of this testing will be supplied to the City of Edmonton upon request.

2.3 PRE-QUALIFYING QUALITY ASSURANCE

The quality assurance laboratory will conduct pre-qualifying tests described in the following paragraphs. Supply paint having the same physical and chemical properties as the samples that have passed the pre-qualifying quality tests.

2.3.1 Preliminary Laboratory Tests (by the City of Edmonton)

- 2.3.1.1 Submit samples of paint when requested by the quality assurance laboratory. Submit a complete paint data form, obtainable from Engineer, for each test sample. Test samples without accompanying paint data forms will not be considered.
- 2.3.1.2 Deliver a minimum of two 4 litre cans of each paint to be tested. Label each can clearly with manufacturer's name and code number. Affix labels that can easily be removed after arrival at the quality assurance laboratory.
- 2.3.1.3 Preliminary laboratory testing for drying time and colour conformance shall be conducted on all tender samples prior to field-testing. Samples which fail to meet the specification requirement for drying time and colour conformance will be rejected from further testing.

2.3.2 Field Tests (by the City of Edmonton)

- 2.3.2.1 A field test consisting of the application of the test paints on a bituminous pavement surface shall be conducted on all paints meeting the preliminary laboratory testing requirements. Uniformity of application, overspray, covering properties and drying time will be evaluated.
- 2.3.2.2 The field test samples will be inspected according to the procedure's outlines in ASTM D713. The following characteristics will be monitored during the test period:
- i. Application characteristics (general appearance, colour, luminous, directional reflectance); and
 - ii. Durability (wear evaluation).
- 2.3.2.3 The overall suitability of the paint will be based on the results obtained in the field test and compliance with all other requirements in this specification.

2.4 QUALITY ASSURANCE FOR SUPPLY

- 2.4.1 Supply paint having the same physical and chemical properties as the samples that passed the pre-qualifying quality tests.
- 2.4.2 The quality assurance laboratory will take and test samples from any shipment or batch of paint. Criteria for accepting each production batch include those requirements listed in Table 2 and manufacturing tolerances.
- 2.4.3 If supply samples do not meet specifications, the Engineer will reject the shipment and corresponding production batch.

Table 2: Acceptance Criteria for Water-Borne Traffic Paint

Criteria	Requirements	TEST METHODS		
		CGSB 1-GP-71	ASTM	Other
Density, kg/l	Within 0.05 kg/l of value from test Sample	Method 2.1		
Color Difference ΔE	Within +/- 1.5 of the value from reference sample			
Composition	Shall not vary by more than +/- 5% of the value from reference sample		D3168	
Total Solids	Shall not vary by more than +/- 2% of the value from reference sample			
pH	Shall not vary by more than one unit of the value from reference sample			
No Pickup Time	Shall be within +/- 2.5 minutes of the value from reference sample		D711	
Directional Reflectance	Minimum value of 70% white Minimum value of 50% Yellow			
Hiding Power	Minimum value of 8.4 m ² /l			

3. EXECUTION

3.1 PACKAGING

- 3.1.1 Prepare paint at factory ready for application. Place in containers that are properly sealed, showing no sign of leakage, and are of the following sizes as specified:
- i. 20-Litre Drum: Round, minimum 24 gauge steel, with properly fitting lid and seal.
 - ii. 205-Litre Drum: Round, minimum 18 gauge steel, with 50mm bung.
- 3.1.2 Each drum shall be clearly marked on the side and the top with weather resistant markings to show the following information:
- i. manufacturer's name and address
 - ii. type of traffic paint
 - iii. colour
 - iv. manufacturer's code and batch numbers and date of filling the drum
 - v. volume of contents in litres

3.2 DELIVERY

- 3.2.1 Deliver paint to designated location in pallets for unloading by forklift.
- 3.2.2 Pick up rejected shipment and replace with paint from another production batch.
- 3.2.3 Pick up emptied containers which remain the property of manufacturer.

END OF SECTION

— Page Left Intentionally Blank —

Construction Specifications Section 02764
Crosswalk and Stopline Painting January 1996

1. GENERAL

1.1 SECTION INCLUDES

Marking crosswalks and stoplines with traffic paint.

1.2 RELATED SECTIONS

Section 02762 Traffic Paint.

2. PRODUCTS

2.1 MATERIALS

Traffic Paint: To Section 02762. Obtain paint only from suppliers pre-qualified by the Engineer.

2.2 EQUIPMENT

Paint Applicator: Subject to approval by the Engineer.

3. EXECUTION

3.1 PREPARATION

3.1.1 Follow safe practices in the Manual of Temporary Traffic Control.

3.1.2 Airblow or sweep pavement surface clean and dry.

3.1.3 Layout indicated paint lines and premark using chalkline or chain stretched across full width of road to ensure straight alignment.

3.1.4 Protect surrounding areas and structures from paint overspray. Remove any smears immediately.

3.2 PAINT APPLICATION

3.2.1 Do not add thinner to paint.

3.2.2 Apply paint to pavement surface with an approved applicator to a dry thickness of 305 um (12 mils).

3.2.3 Paint lines as indicated on plans or as directed by the Engineer.

3.3 QUALITY ASSURANCE

3.3.1 The Engineer will reject paint lines that are not straight, are oversprayed, have insufficient thickness, are painted on dirty surfaces, or are tracked.

3.3.2 Repair, or remove and repaint, faulty paint lines as directed by the Engineer.

3.4 PROTECTION AND CLEANUP

3.4.1 Do not open newly painted lines to traffic until paint has dried sufficiently so it cannot be tracked.

3.4.2 On completion of work, leave site clean and free of paint smears and debris.

END OF SECTION



— Page Left Intentionally Blank —

Construction Specifications **Section 02766**
Lane Markings - Hot Applied Paint **February 1997**

1. GENERAL

1.1 SECTION INCLUDES

Lane line markings in White and Yellow traffic paint.

1.2 RELATED SECTION

Section 02762 Traffic paint.

2. PRODUCTS

2.1 MATERIAL

Traffic Paint: to Section 02762. Obtain paint from suppliers pre-qualified by the Engineer.

2.2 EQUIPMENT

Paint applicator: Subject to approval by the Engineer.

3. EXECUTION

3.1 PREPARATION

3.1.1 Follow safe practices in the Manual of Temporary Traffic Control.

3.1.2 Do not apply paint markings until pre-markings have passed inspection by the Engineer.

3.2 PAINT APPLICATION

3.2.1 Do not add thinner to paint.

3.2.2 Apply paint to pavement surface with approved applicator to a dry thickness of 305 um (12 mils).

3.2.3 Paint the lines as indicated on list of locations and plans or as directed by the Engineer.

3.3 QUALITY ASSURANCE

3.3.1 The Engineer will reject paint lines that are not straight, are oversprayed, have insufficient thickness, are painted on dirty surfaces, or are tracked.

3.3.2 Repair, or remove and repaint, faulty paint lines as directed by the Engineer. The repairs shall be done at no extra cost to the City.

3.4 PROTECTION AND CLEANUP

3.4.1 Do not permit traffic over applied markings until they have adequately dried.

3.4.2 Protect surrounding areas and structures from paint overspray. Remove any smears immediately.

3.4.3 On completion of work, leave site clean and free of paints smears and debris.

END OF SECTION



— Page Left Intentionally Blank —

Section 02767

Construction Specifications Prefabricated Roadmarking Material April 2012

1. GENERAL

1.1 SECTION INCLUDES

- 1.1.1 Supply and installation of pavement markings in White and Yellow prefabricated roadmarking material.
- 1.1.2 The City of Edmonton Pavement Marking Guidelines shall be referred to as the primary standard for use in conjunction with plans issued where further details and dimensional clarification is needed. The term “guidelines” shall be construed as mandatory standards to be adhered to.

1.2 REFERENCES

- ASTM D638 – Test Method for Tensile Properties of Plastics
- ASTM D523 – Test Method for Specular Gloss
- ASTM E303 – Test Method for Measuring Surface Frictional Properties Using the British Pendulum Tester
- Federal Test Method Standard No. 141a (Method 6192) - Test Method for Abrasion Resistance
- Federal Test Method Standard 370 - Test Method for Retroreflectivity

2. PRODUCTS

2.1 MATERIAL

2.1.1 General Requirements

- 2.1.1.1 The reflective preformed plastic pavement marking material shall consist of a ribbon of specified thickness and width, which shall contain optical glass spheres uniformly distributed throughout the entire cross section, and shall be capable of being affixed to asphalt pavements by means of a pre-coated adhesive and pressure. The edge shall be clean cut and true. The material shall be capable of conforming to the pavement contours and irregularities. The material shall be impervious to sunlight, water, oil, gasoline or salt. It shall have adequate bonding strength to resist normal snow removal operations.
- 2.1.1.2 The preformed plastic material shall be capable of being applied to new asphalt pavement used by the City of Edmonton immediately prior to the final rolling of the new surface and of being rolled (flush with the asphalt surface) into place with conventional pavement rollers, using the “inlaid” process.
- 2.1.1.3 The preformed plastic material shall not require a pavement primer or cleaner or need any special preparation such as heat pots or activator liquids.
- 2.1.1.4 The plastic and adhesive shall be of the type that the water used on the pavement roller to prevent asphalt pick up shall not be harmful to the successful application of the plastic.
- 2.1.1.5 The material shall have a pre-coated adhesive.
- 2.1.1.6 The pigments shall be selected and blended to provide a marking film as follows :

a) White Colour:

Conforming to U.S. Federal Standard 595B Colour Number 37925, or CGSB 1-GP-12.1C, White 513-301. 70% minimum when measured with Colour Guide reflectometer 0,45° daylight luminous directional reflectance, with a green filter.

b) Yellow Colour:

Conforming to U.S. Federal Standard 595B, Color Number 33538, or CGSB color #505-308 40% minimum when measured with the Colour Guide reflectometer 0,45° daylight luminous directional reflectance, with a green filter.

The tolerance in colour allowed is as follows in the CIE L*, a*, b* Uniform Color Space and Colour Difference Equation when calculated from instrumentally measured colour differences conforming to ASTM D 2244:

White L* = +2 and -1.5 max
 a* = +1.5 and -1 max
 b* = +4 and -4 max

Yellow - MTO L* = +2 and -1.5 max
 a* = +1.5 and -1 max
 b* = +4 and -4 max

Yellow - U.S. L* = -2 and +4 max
 a* = -6 and +4 max
 b* = -9 and +10 max

2.2 SPECIFIC REQUIREMENTS

2.2.1 Retroreflectivity:

The white and yellow films shall have the following initial reflectance values at 0.2° and 0.5° observation angles and 86° entrance angle as measured in accordance with the testing procedures of Federal Test Method Standard 370. The photo-metric quantity to be measured shall be specific luminance (SL), and shall be expressed as millicandelas per square meter per lux. The test distance shall be 15 m and the sample size shall be a 76 x 61 cm rectangle.

The angular aperture of both the photoreceptor and light projector shall be 6 minutes of arc. The reference centre shall be the geometric centre of the sample, and the reference axis shall be taken perpendicular to the test sample.

Observance Angle	White		Yellow	
	0.2°	0.5°	0.2°	0.5°
SL (mcd m ⁻²) x lx ⁻¹	550	380	410	250

2.2.2 Blend Test No. 1 (with pre-coated adhesive):

The plastic shall be of such a structure that at a temperature of 26.7° C, a piece of 7.62 cm x 15.24 cm material (with paper packing) placed upon a 2.54 cm diameter mandrel may be bent over the mandrel until the end faces are parallel and 2.54 cm apart. By visual inspection , there shall be no fracture lines apparent in the uppermost surface.

2.2.3 Blend Test No. 2 (without paper backing):

A piece of plastic 15.24 cm x 30.48 cm in size (paper backing removed) when balanced upon a supported 1.27 cm diameter mandrel, reflective side up, and left in this position at a temperature of 26.7 °C shall have flexed out of its own weight at the end of eight hours into an inverted “V” position with the free ends at an angle of not more than 30° from the vertical. The uppermost surface of the plastic shall show no fracture or breaks. Upon removing the plastic from the mandrel, the material should be firmly but not abruptly returned to a semi-flat position with the reflective side down. The plastic, at a temperature of 26.7° C on a smooth, flat, glass surface shall have returned to its original flat condition in not more than eight hours.

2.2.4 Tensile Strength and Elongation:

a) Type I Performed Plastic (90 Mil)

Employing ASTM designation D-638, the plastic shall have a minimum tensile strength of 2,070 kPa ± 680 kPa. The tensile strength calculations shall be based on the minimum measured thickness of the test specimen.

The rate of pull on the test shall be 6.35 mm per minute. The test shall be conducted at a temperature of 21.1° to 26.7° C, using a strip of material 15.24 cm long and 2.54 cm wide. The elongation shall be no less than 75 percent at break.

b) Type II Preformed Plastic (60Mil)

Employing ASTM designation D-638, the plastic shall have a minimum tensile strength of 1,035 kPa ± 340 kPa. The tensile strength calculations shall be based on the minimum measured thickness of the test specimen. The rate of pull on the test shall be 6.35 mm per minute. The test shall be conducted at a temperature of 21.1° to 26.7° C, using a strip of material 15.24 cm long and 2.54 cm wide. The elongation shall be no less than 75 percent at break.

2.2.5 Reflectivity Retention:

To have a good effective performance life, the glass beads must be strongly bonded and not be easily removed by traffic wear.

The following test shall be employed to measure reflectivity retention :

Taber Abraser Simulation Test :

Using a Taber Abraser with an H-18 wheel and a 125 gram load, the sample shall be inspected at 50, 100, and 200 cycles, under a microscope, to observe the extent and type of bead failure.

No more than 15% of the beads shall be lost due to pop-out and the predominant mode of failure shall be “wear-down” of the beads.

2.2.6 Gloss:

The plastic material shall have a maximum 60° gloss of 10 units as measured in accordance with ASTM designation D-523.

2.2.7 Thickness:

a) Type I Preformed Plastic (90 Mil)

The plastic material, without adhesive and without the top coat of glass beads, shall be a minimum of 2.286 mm thickness.

b) Type II Preformed Plastic (60 Mil)

The plastic material, without adhesive and without the top coat of glass beads, shall be a minimum of 1.524 mm in thickness.

2.2.8 Static Load Strength:

The test specimen cut to dimensions of 2.5 cm x 15.2 cm shall support a dead load weight of 2.7 kg for no less than 30 minutes. This test shall be conducted at a temperature of 21° - 27° C.

2.2.9 Skid Resistance:

The surface of the retroreflective pavement marking film shall provide a minimum skid-resistance value of 45 BPN when tested according to ASTM E-303.

2.2.10 Abrasion Resistance:

The plastic marker shall have a maximum loss in weight of 0.25 grams in 500 revolutions when abraded according to Federal Test Method Standard No 141a (method 6192), using H-18 calibrase wheels with 1,000 gram load on each wheel.

All test panels will be given a 200 cycle conditioning before the actual test is run. This is necessary to remove the coating of glass beads.

2.2.11 Adhesive System:

The pre-coated adhesive backing shall be formulated expressly for use on bituminous pavement. It shall be 100% solids and non-flammable at application.

2.2.12 Adhesive Shear Strength:

Specimens shall be tested according to the method described in ASTM designation D-638-68 as modified. The samples shall be prepared as follows : The test specimen shall be cut to dimensions of 2.5 cm x 15.2 cm. A 2.5 cm x 7.6 cm piece of Carborundum extra coarse emery cloth, or its equivalent, shall be applied to the adhesive face of the test strip so that there is a 6.5 cm overlap. A pressure to 415 kPa shall be applied over the overlapped area for a period of 120 seconds. Load is applied by gripping each end of the laminated test piece in a suitable tensile test machine such as a Dillon or Scott tester. The average load requirement to break the adhesive bond shall not be less than 4.54 kg. The speed of testing shall be .64 cm per minute. The test shall be run in triplicate and at 25° C.

2.2.13 Patchability:

The material shall be capable of fusing into worn areas of previously applied material of the same type and composition of film following manufacturer's recommended patching procedures.

3. EXECUTION

3.1 PREPARATION

3.1.1 Follow safe practices in the Manual of Temporary Traffic Control.

3.1.2 Do not apply prefabricated roadmarking material until pre-markings have passed inspection by the Engineer.

3.2 APPLICATION

3.2.1 The prefabricated roadmarking material shall be applied to the new asphalt pavement immediately prior to the final rolling of the new surface and being rolled into place with conventional pavement rollers, using the "inlaid" process.

- 3.2.2 The prefabricated roadmarking material shall not be applied where there is an asphalt seam. This restriction may be altered by authorized Transportation Operations personnel.
- 3.2.3 The Contractor shall provide to Transportation Operations all times and dates for the premarking and prefabricated marking installations.
- 3.2.4 Premarking shall be applied immediately after the new asphalt pavement but before the final rolling of the new surface.
- 3.2.5 Final markings shall be applied immediately after the new asphalt pavement but before the final rolling of the new surface.
- 3.2.6 All premarking to be done with premarking paint approved by Transportation Operations personnel. Prior to the placement of the prefabricated roadmarking material, all premarking must be approved by authorized Transportation Operations personnel. Changes in the alignment of markings that do not correspond to the plans may be made in the field by authorized Traffic Operations personnel. All premarking lines remaining after a period of 6 weeks must be removed or blackened out by the Contractor at the Contractor's expense.
- 3.2.7 Removal and reinstallation of all conflicting markings, paint or permanent, is the responsibility of the Contractor and shall be done immediately after the installation of new markings. The method and type of material to be used shall be approved by authorized Traffic Operations personnel.
- 3.2.8 Any changes made in the field that are 10 cm or greater must be approved by authorized Traffic Operations personnel and shall be recorded by the Contractor on the plans. Field returns must be in the possession of the Traffic Operations inspector upon final marking inspection of the job. All plans shall be signed by the Contractor, regardless whether changes were necessary or not.

3.3 METHOD OF PAYMENT

- 3.3.1 **Line Marking:** measured by the meter of material installed.
- 3.3.2 **Arrows :** measured by the number of arrows installed.
- 3.3.3 **Zebra Crosswalks :** measured by the number of bars installed.
- 3.3.4 **Removal of Markings:**
 - 3.3.4.1 **Plastic:** same as for the type of markings installed.
 - 3.3.4.2 **Paint Markings:** shall be on a cost plus basis.

3.4 BASIS OF PAYMENT

Prefabricated Roadmarking Material: Includes cleaning of pavement surface (if required); layout and premarking; supplying of prefabricated roadmarking material; traffic control and cleanup.

3.5 PROTECTION AND CLEANUP

- 3.5.1 On completion of work, leave site clean and free of debris and waste matter .
- 3.5.2 Do not permit traffic over applied markings until they have adequately set.

END OF SECTION



— Page Left Intentionally Blank —



Construction Specifications

**Section 02768
MMA Spray Plastic**

February 2000

1. GENERAL

This section provides the specification for the supply of MMA spray plastic traffic marking material.

2. PRODUCT

MMA spray plastic shall conform to the following specification

Tests	Minimum Requirements	Maximum Requirements	Test Method A.S.T.M.
Abrasion Resistance * (maximum loss /grams)	-	0.45g	D4060
Reflectance White - Yellow -	75% 45%	- -	E1347
Retroreflectance (with proper bead application)	200 millicandelas per square metre per lux		
Specific Gravity @ 25° C (77°F)	1.8	-	D792
Hardness	A-2 Shore 70		D2240
Water Absorption		0.5%	D570
Chemical resistance to anti-freeze brake fluid motor oil diesel fuel, gasoline calcium chloride sodium chloride transmission fluid	No signs of degradation after 7 days immersion		
Adhesion ** (to Portland Cement)	200 psi		
Skid Resistance (Field Base)	45 units		E303

* Abrasion resistance, maximum weight loss when subjected to 200 revolutions on Taber Abrader at 25° C using H-22 Calibrade wheels weighted to 500 grams with sample kept continuously wet with distilled water. Prepare test sample with representative material placed on 100mm square plate, 2 ±0.1 mm thickness.

** Adhesion to asphalt is dependent on the tensile failure strength of the substrate. This compound shall be resistant to the effect of ultra-violet light.

3. GLASS BEADS

Glass Beads shall conform to specification Section 02761.

END OF SECTION